



Fixed Service Bands in New Zealand (PIB 22)

Issue 9 | November 2015



CONTENTS

<u>Contents, Disclaimer, Changes, Clarification and Corrections</u>	<u>5</u>
<u>EE Band 162.20 - 170.31 MHz</u>	<u>7</u>
<u>12.5 kHz Channelling</u>	<u>7</u>
<u>25 kHz Channelling</u>	<u>8</u>
<u>Band Plan for EE Band 162.2 - 162.45 and 165.45 - 165.7 MHz</u>	<u>9</u>
<u>I Band 404 - 430 MHz</u>	<u>10</u>
<u>25 kHz Channelling</u>	<u>10</u>
<u>50 kHz Channelling</u>	<u>12</u>
<u>75 kHz Channelling</u>	<u>13</u>
<u>100 kHz Channelling</u>	<u>14</u>
<u>150 kHz Channelling</u>	<u>14</u>
<u>Band Plan for I Band 404 - 430 MHz</u>	<u>15</u>
<u>JL Band 440 - 449 MHz</u>	<u>16</u>
<u>12.5 kHz Channelling</u>	<u>16</u>
<u>25 kHz Channelling</u>	<u>18</u>
<u>50 kHz Channelling</u>	<u>20</u>
<u>75 kHz Channelling</u>	<u>20</u>
<u>150 kHz Channelling</u>	<u>20</u>
<u>300 kHz Channelling</u>	<u>20</u>
<u>Band Plan for JL Band 440 - 449 MHz</u>	<u>21</u>
<u>J Band 450 - 470 MHz</u>	<u>22</u>
<u>12.5 kHz Channelling</u>	<u>22</u>
<u>25 kHz Channelling</u>	<u>24</u>
<u>50 kHz Channelling</u>	<u>25</u>
<u>12.5 kHz Channelling</u>	<u>26</u>
<u>25 kHz Channelling</u>	<u>27</u>
<u>50 kHz Channelling</u>	<u>27</u>
<u>Band Plan for J Band 450 - 470 MHz</u>	<u>28</u>
<u>KL Band 841 - 851 MHz</u>	<u>29</u>
<u>250 kHz Channelling (Monophonic, dual monophonic services)</u>	<u>29</u>
<u>500 kHz Channelling (Composite stereophonic services)</u>	<u>30</u>
<u>Band Plan for KL Band 841 - 851 MHz</u>	<u>30</u>
<u>KK Band 806 - 812 / 851 - 857 MHz</u>	<u>31</u>
<u>500 kHz Channelling</u>	<u>31</u>
<u>Band Plan for KK Band 806 - 812/851 - 857 MHz</u>	<u>31</u>
<u>K Band 915 - 935 MHz</u>	<u>32</u>
<u>250 kHz Channelling (Monophonic, dual monophonic services)</u>	<u>32</u>
<u>500 kHz Channelling (Composite stereophonic services)</u>	<u>33</u>
<u>Band Plan for K Band 915 - 921 / 929 - 935 MHz</u>	<u>34</u>
<u>LL Band 1427 - 1525 MHz</u>	<u>35</u>
<u>75 kHz Channelling</u>	<u>35</u>
<u>150 kHz Channelling</u>	<u>35</u>
<u>250 kHz Channelling</u>	<u>36</u>
<u>Band Plan for LL Band 1427 - 1525 MHz</u>	<u>37</u>
<u>L Band 1427 - 1525 MHz</u>	<u>38</u>
<u>4 MHz Channelling</u>	<u>38</u>
<u>2 MHz Channelling</u>	<u>38</u>

<u>Band Plan for L Band 1427 - 1525 MHz</u>	39
<u>2G8 Band 2700 - 2900 MHz</u>	40
TVOB 10 MHz Channelling	40
TVOB 28 MHz Channelling	40
<u>Band Plan for 2G8 Band 2700 - 2900 MHz</u>	41
<u>4 GHz Band 3600 - 4200 MHz</u>	42
40 MHz Channelling	42
<u>Band Plan for 4 GHz Band 3600 - 4200 MHz</u>	42
<u>5 GHz Band 4400 - 5000 MHz</u>	43
40 MHz Channelling	43
<u>Band Plan for 5 GHz Band 4400 - 5000 MHz</u>	43
<u>6 GHz Band 5925 - 6420 MHz</u>	44
29.65 MHz Channelling	44
<u>Band Plan for 6 GHz Band 5925 - 6420 MHz</u>	45
<u>7GHz (Lower) Band 6430 - 7100 MHz</u>	46
40 MHz Channelling	46
<u>Band Plan for 7 GHz (Lower) Band 6420 - 7100 MHz</u>	47
<u>7 GHz (Middle) Band 7100 - 7425 MHz</u>	48
56 MHz Channelling	48
28 MHz Channelling	48
14 MHz Channelling	48
7 MHz Channelling	48
3.5 MHz Channelling	49
TVOB 28 MHz Channelling	49
<u>Band Plan for 7 GHz (Middle) Band 7100 - 7425 MHz</u>	50
<u>7 GHz (Upper) Band 7425 - 7725 MHz</u>	51
56 MHz Channelling	51
28 MHz Channelling	51
14 MHz Channelling	51
7 MHz Channelling	51
<u>Band Plan for 7 GHz (Upper) Band 7425 - 7725 MHz</u>	53
<u>8 GHz (Lower) Band 7725 - 8275 MHz</u>	54
59.3 MHz Channelling	54
29.65 MHz Channelling	54
<u>Band Plan for 8 GHz (Lower) Band 7725 - 8275 MHz</u>	55
<u>8 GHz (Upper) Band 8275 - 8500 MHz</u>	56
28 MHz Channelling	56
<u>Band Plan for 8 GHz (Upper) Band 8275 - 8500 MHz</u>	56
<u>10 GHz Band 10.5 - 10.68 GHz</u>	57
21 MHz Channelling	57
7 MHz Channelling	57
<u>Band Plan for 10 GHz Band 10.5 - 10.68 GHz</u>	58
<u>11 GHz Band 10.7 - 11.7 GHz</u>	59
80 MHz Channelling	59
40 MHz Channelling	59
<u>Band Plan for 11 GHz Band 10.7 - 11.7 GHz</u>	60
<u>13 GHz Band 12.75 - 13.25 GHz</u>	61
56 MHz Channelling	61
28 MHz Channelling	61
14 MHz Channelling	61

7 MHz Channelling	62
Band Plan for 13 GHz Band 12.75 - 13.25 GHz	63
15 GHz Band 14.5 - 15.35 GHz	64
28 MHz Channelling	64
14 MHz Channelling	64
7 MHz Channelling	64
3.5 MHz Channelling	65
Band Plan for 15 GHz Band 14.5 - 15.35 GHz	66
18 GHz Band 17.7 - 19.7 GHz	67
110 MHz Channelling	67
55 MHz Channelling	67
27.5 MHz Channelling	67
7 MHz Channelling	68
Band Plan for 18 GHz Band 17.7 - 19.7 GHz	69
23 GHz Band 21.2 - 23.6 GHz	70
112 MHz Channelling	70
56 MHz Channelling	70
Special channels for forward video/reverse camera control	70
28 MHz Channelling	71
14 MHz Channelling	72
7 MHz Channelling	73
Band Plan for 23 GHz Band 21.2 - 23.6 GHz	75
38 GHz Band 37.0 - 40.0 GHz	76
56 MHz Channelling	76
28 MHz Channelling	76
14 MHz Channelling	77
7 MHz Channelling	79
3.5 MHz Channelling	80
Band Plan for 38 GHz Band 37.0 - 40.0 GHz	81
50 GHz Band 50.4 - 51.15 GHz	82
40 MHz Channelling	82
10 MHz Channelling	82
Band Plan for 50 GHz Band 50.4 - 51.15 GHz	83
80 GHz Band 71.125 - 85.875 GHz	84
2250 MHz Channelling	84
1750 MHz Channelling	84
1250 MHz Channelling	84
250 MHz Channelling	85
Band Plan for 80 GHz Band 71.125 – 75.875 / 81.125 – 75.875 GHz	86
APPENDIX 1	87

Contents, Disclaimer, Changes, Clarification and Corrections

Contents

This Public Information Brochure (PIB 22) is intended as a convenient reference to the bands used in the Fixed Service, showing details of channel frequencies and separations between the 'go' and 'return' channels. In some bands, interleaved plans are used. Notes identify where interleaved plans exist.

Some general principles governing the arrangement of Fixed Service bands are as follows:

- At any particular site, all the 'go' channels should be in one half of the band, and all the 'return' channels should be in the other half of the band.
- Care needs to be taken to consider adjacent bands when referring to channels and bands in this document.
- It is often desirable that alternate polarisation should be used for adjacent channels operating in the same half of the band.
- There are considerable advantages in using a uniform frequency channelling arrangement which can accommodate a range of system capacities.
- The inclusion of a band plan, or a particular channel in any band plan, does not necessarily mean that the band or channel is available for licensing.

This document should be read in conjunction with the Radio Licence Policy Rules (PIB 58) and the Radio Licence Certification Rules (PIB 38).

Disclaimer

The Ministry of Business, Innovation and Employment (the Ministry) makes no warranty, express or implied, nor assumes any liability for any loss suffered, whether arising directly, or indirectly, due to the sole reliance on the accuracy or contents of this Public Information Brochure (PIB 22).

Changes

Radio Spectrum Management (RSM) may change, delete or add to or otherwise amend information contained in the document from time to time to reflect evolving policies. Changes to this document will be notified through the 'Radio Spectrum Management Business Update' newsletter that is emailed to those who subscribe. The changes are also notified in the news section on the RSM website, www.rsm.govt.nz.

Clarification and Corrections

RSM will provide clarification of the information contained in this document when requested and would appreciate receiving suggestions for its improvement or advice relating to inaccuracies or ambiguities. Such matters may be emailed to radio.spectrum@mbie.govt.nz.

Correspondence received will be acknowledged, investigated and appropriate action taken.

ISSN 1175-6748 (PDF)

Amendment History

Issue	Date	Amendment details	Authorised by
3	May 1988		TR Cudby
4	June 2002		A Mulcahy
5	June 2009	400 MHz plans revised band plots added. 80GHz band added and O and 60GHZ bands removed	B Miller
6	August 2011	Added KL band and made editorial amendments.	L Starling
7	November 2011	Added 56 MHz channels for V, U, X and 38 GHz bands	L Starling
8	March 2014	Reformatted and editorial amendments	L Starling
9	November 2015	Renaming of bands from 2 - 15 GHz and the removal of unused band plans at 6, 7 & 23 GHz	L Starling

EE Band 162.20 - 170.31 MHz

12.5 kHz Channelling			
Channel	Frequency	Channel	Frequency
EE1	162.21250	EE1#	166.81250
EE2	162.22500	EE2#	166.82500
EE3	162.23750	EE3#	166.83750
EE4	162.25000	EE4#	166.85000
EE5	162.26250	EE5#	166.86250
EE6	162.27500	EE6#	166.87500
EE7	162.28750	EE7#	166.88750
EE8	162.30000	EE8#	166.90000
EE9	162.31250	EE9#	166.91250
EE10	162.32500	EE10#	166.92500
EE11	162.33750	EE11#	166.93750
EE12	162.35000	EE12#	166.95000
EE13	162.36250	EE13#	166.96250
EE14	162.37500	EE14#	166.97500
EE15	162.38750	EE15#	166.98750
EE16	162.40000	EE16#	167.00000
EE17	162.41250	EE17#	167.01250
EE18	162.42500	EE18#	167.02500
EE19	162.43750	EE19#	167.03750
EE20	162.45000	EE20#	167.05000
EE261	165.46250	EE261#	170.06250
EE262	165.47500	EE262#	170.07500
EE263	165.48750	EE263#	170.08750
EE264	165.50000	EE264#	170.10000
EE265	165.51250	EE265#	170.11250
EE266	165.52500	EE266#	170.12500
EE267	165.53750	EE267#	170.13750
EE268	165.55000	EE268#	170.15000
EE269	165.56250	EE269#	170.16250
EE270	165.57500	EE270#	170.17500
EE271	165.58750	EE271#	170.18750
EE272	165.60000	EE272#	170.20000
EE273	165.61250	EE273#	170.21250
EE274	165.62500	EE274#	170.22500
EE275	165.63750	EE275#	170.23750
EE276	165.65000	EE276#	170.25000
EE277	165.66250	EE277#	170.26250
EE278	165.67500	EE278#	170.27500
EE279	165.68750	EE279#	170.28750
EE280	165.70000	EE280#	170.30000

25 kHz Channelling			
Channel	Frequency	Channel	Frequency
EEW1	162.21875	EEW1#	166.81875
EEW2	162.24375	EEW2#	166.84375
EEW3	162.26875	EEW3#	166.86875
EEW4	162.29375	EEW4#	166.89375
EEW5	162.31875	EEW5#	166.91875
EEW6	162.34375	EEW6#	166.94375
EEW7	162.36875	EEW7#	166.96875
EEW8	162.39375	EEW8#	166.99375
EEW9	162.41875	EEW9#	167.01875
EEW10	162.44375	EEW10#	167.04375
EEW261	165.46875	EEW261#	170.06875
EEW262	165.49375	EEW262#	170.09375
EEW263	165.51875	EEW263#	170.11875
EEW264	165.54375	EEW264#	170.14375
EEW265	165.56875	EEW265#	170.16875
EEW266	165.59375	EEW266#	170.19375
EEW267	165.61875	EEW267#	170.21875
EEW268	165.64375	EEW268#	170.24375
EEW269	165.66875	EEW269#	170.26875
EEW270	165.69375	EEW270#	170.29375

Note: These channels (EEW) are allocated for the use of high efficiency digital services using advanced modulation methods.

See Radio Licence Policy Rules (PIB 58) and Radio Licence Certification Rules (PIB 38).

Band Plan for EE Band 162.2 - 162.45 and 165.45 - 165.7 MHz

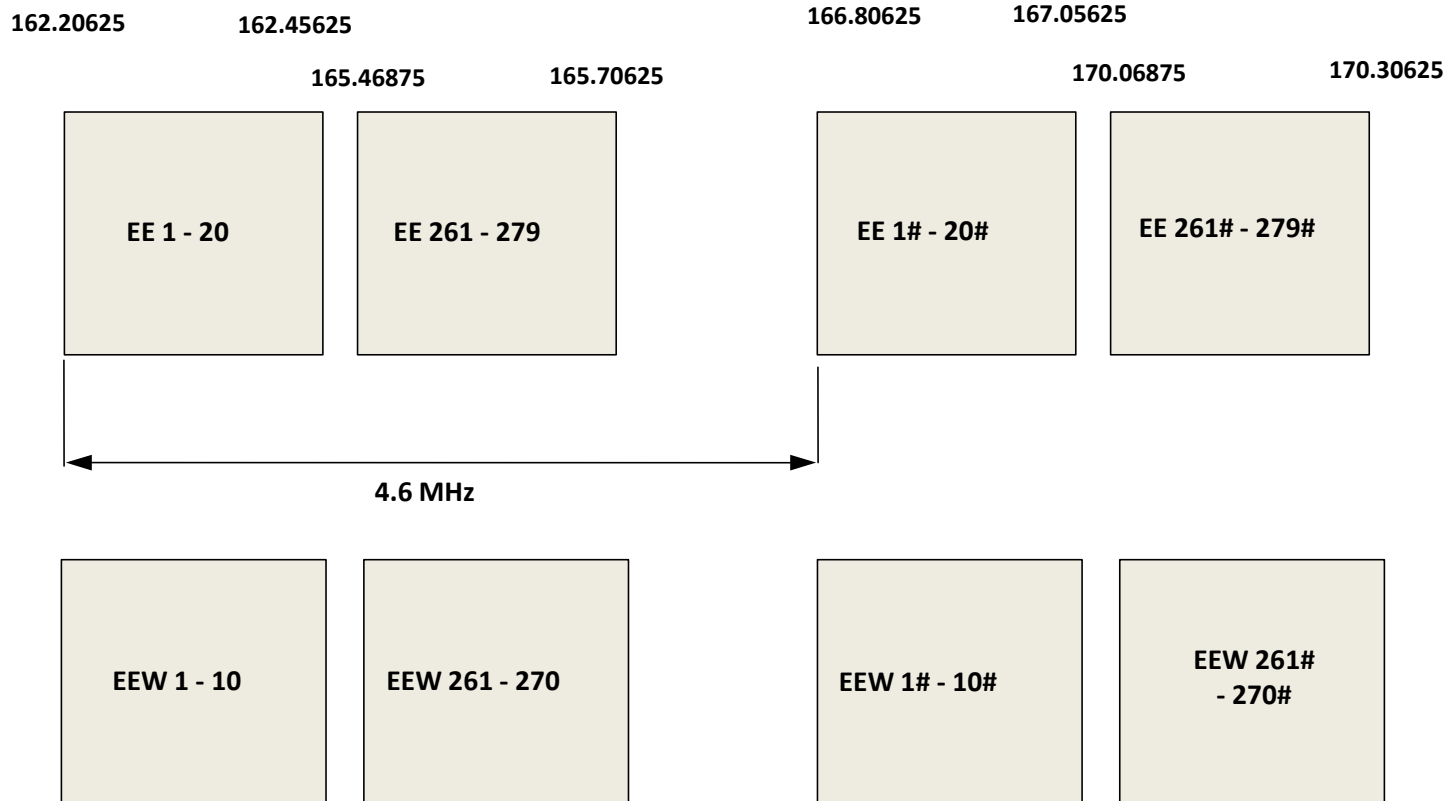

Channelling: 12.5 and 25 kHz

Note: EE21/EE21# to EE260/EE206# are for land mobile services

I Band 404 - 430 MHz

Note: See Radio Licence Policy Rules (PIB 58) and Radio Licence Certification Rules (PIB 38).

25 kHz Channelling			
Group F			
Channel	Frequency	Channel	Frequency
I501	420.01250	I501#	425.02500
I502	420.03750	I502#	425.05000
I503	420.06250	I503#	425.07500
I504	420.08750	I504#	425.10000
I505	420.11250	I505#	425.12500
I506	420.13750	I506#	425.15000
I507	420.16250	I507#	425.17500
I508	420.18750	I508#	425.20000
I509	420.21250	I509#	425.22500
I510	420.23750	I510#	425.25000
I511	420.26250	I511#	425.27500
I512	420.28750	I512#	425.30000
I513	420.31250	I513#	425.32500
I514	420.33750	I514#	425.35000
I515	420.36250	I515#	425.37500
I516	420.38750	I516#	425.40000
I517	420.41250	I517#	425.42500
I518	420.43750	I518#	425.45000
I519	420.46250	I519#	425.47500
I520	420.48750	I520#	425.50000
I521	420.51250	I521#	425.52500
I522	420.53750	I522#	425.55000
I523	420.56250	I523#	425.57500
I524	420.58750	I524#	425.60000
I525	420.61250	I525#	425.62500
I526	420.63750	I526#	425.65000
I527	420.66250	I527#	425.67500
I528	420.68750	I528#	425.70000
I529	420.71250	I529#	425.72500
I530	420.73750	I530#	425.75000
I531	420.76250	I531#	425.77500
I532	420.78750	I532#	425.80000
I533	420.81250	I533#	425.82500
I534	420.83750	I534#	425.85000
I535	420.86250	I535#	425.87500
I536	420.88750	I536#	425.90000
I537	420.91250	I537#	425.92500
I538	420.93750	I538#	425.95000
I539	420.96250	I539#	425.97500
I540	420.98750	I540#	426.00000
I541	421.01250	I541#	426.02500
I542	421.03750	I542#	426.05000

25 kHz Channelling			
Group F (continued)			
Channel	Frequency	Channel	Frequency
I543	421.06250	I543#	426.07500
I544	421.08750	I544#	426.10000
I545	421.11250	I545#	426.12500
I546	421.13750	I546#	426.15000
I547	421.16250	I547#	426.17500
I548	421.18750	I548#	426.20000
I549	421.21250	I549#	426.22500
I550	421.23750	I550#	426.25000
I551	421.26250	I551#	426.27500
I552	421.28750	I552#	426.30000
I553	421.31250	I553#	426.32500
I554	421.33750	I554#	426.35000
I555	421.36250	I555#	426.37500
I556	421.38750	I556#	426.40000
I557	421.41250	I557#	426.42500
I558	421.43750	I558#	426.45000
I559	421.46250	I559#	426.47500
I560	421.48750	I560#	426.50000
I561	421.51250	I561#	426.52500
I562	421.53750	I562#	426.55000
I563	421.56250	I563#	426.57500
I564	421.58750	I564#	426.60000
I565	421.61250	I565#	426.62500
I566	421.63750	I566#	426.65000
I567	421.66250	I567#	426.67500
I568	421.68750	I568#	426.70000
I569	421.71250	I569#	426.72500
I570	421.73750	I570#	426.75000
I571	421.76250	I571#	426.77500
I572	421.78750	I572#	426.80000
I573	421.81250	I573#	426.82500
I574	421.83750	I574#	426.85000
I575	421.86250	I575#	426.87500
I576	421.88750	I576#	426.90000
I577	421.91250	I577#	426.92500
I578	421.93750	I578#	426.95000
I579	421.96250	I579#	426.97500
I580	421.98750	I580#	427.00000
I581	422.01250	I581#	427.02500
I582	422.03750	I582#	427.05000
I583	422.06250	I583#	427.07500
I584	422.08750	I584#	427.10000
I585	422.11250	I585#	427.12500
I586	422.13750	I586#	427.15000
I587	422.16250	I587#	427.17500
I588	422.18750	I588#	427.20000

25 kHz Channelling**Group F (continued)**

Channel	Frequency	Channel	Frequency
I589	422.21250	I589#	427.22500
I590	422.23750	I590#	427.25000
I591	422.26250	I591#	427.27500
I592	422.28750	I592#	427.30000
I593	422.31250	I593#	427.32500
I594	422.33750	I594#	427.35000
I595	422.36250	I595#	427.37500
I596	422.38750	I596#	427.40000
I597	422.41250	I597#	427.42500
I598	422.43750	I598#	427.45000
I599	422.46250	I599#	427.47500
I600	422.48750	I600#	427.50000
I601	422.51250	I601#	427.52500

50 kHz Channelling**Group G**

Channel	Frequency	Channel	Frequency
I603	422.56250	I603#	427.57500
I605	422.61250	I605#	427.62500
I607	422.66250	I607#	427.67500
I609	422.71250	I609#	427.72500
I611	422.76250	I611#	427.77500
I613	422.81250	I613#	427.82500
I615	422.86250	I615#	427.87500
I617	422.91250	I617#	427.92500
I619	422.96250	I619#	427.97500
I621	423.01250	I621#	428.02500
I623	423.06250	I623#	428.07500
I625	423.11250	I625#	428.12500
I627	423.16250	I627#	428.17500
I629	423.21250	I629#	428.22500
I631	423.26250	I631#	428.27500
I633	423.31250	I633#	428.32500
I635	423.36250	I635#	428.37500
I637	423.41250	I637#	428.42500
I639	423.46250	I639#	428.47500
I641	423.51250	I641#	428.52500
I643	423.56250	I643#	428.57500
I645	423.61250	I645#	428.62500
I647	423.66250	I647#	428.67500
I649	423.71250	I649#	428.72500
I651	423.76250	I651#	428.77500
I653	423.81250	I653#	428.82500

50 kHz Channelling			
Group G (continued)			
Channel	Frequency	Channel	Frequency
I655	423.86250	I655#	428.87500
I657	423.91250	I657#	428.92500
I659	423.96250	I659#	428.97500
I661	424.01250	I661#	429.02500
I663	424.06250	I663#	429.07500
I665	424.11250	I665#	429.12500
I667	424.16250	I667#	429.17500
I669	424.21250	I669#	429.22500
I671	424.26250	I671#	429.27500
I673	424.31250	I673#	429.32500
I675	424.36250	I675#	429.37500
I677	424.41250	I677#	429.42500
I679	424.46250	I679#	429.47500
I681	424.51250	I681#	429.52500
I683	424.56250	I683#	429.57500
I685	424.61250	I685#	429.62500
I687	424.66250	I687#	429.67500
I689	424.71250	I689#	429.72500
I691	424.76250	I691#	429.77500
I693	424.81250	I693#	429.82500
I695	424.86250	I695#	429.87500
I697	424.91250	I697#	429.92500
I699	424.96250	I699#	429.97500

75 kHz Channelling			
Group A			
Channel	Frequency	Channel	Frequency
I1	404.03750	I1#	412.03750
I2	404.11250	I2#	412.11250
I3	404.18750	I3#	412.18750
I4	404.26250	I4#	412.26250
Group E			
Channel	Frequency	Channel	Frequency
I15	405.73750	I15#	413.73750
I16	405.81250		
I17	405.88750		
I18	405.96250		

I Band 404 - 430 MHz

100 kHz Channelling

Group I			
Channel	Frequency	Channel	Frequency
I9	404.95000	I9#	412.95000
I10	405.05000	I10#	413.05000

150 kHz Channelling

Group B			
Channel	Frequency	Channel	Frequency
I5	404.37500	I5#	412.37500
I6	404.52500	I6#	412.52500
I7	404.67500	I7#	412.67500
I8	404.82500	I8#	412.82500
Group D			
Channel	Frequency	Channel	Frequency
I11	405.17500	I11#	413.17500
I12	405.32500	I12#	413.32500
I13	405.47500	I13#	413.47500
I14	405.62500	I14#	413.05000

Note: The fixed service channels I1 - I18 / I1# - I15# are restricted for studio-transmitter links only. Although shown as channel pairs, they are assigned and used as unidirectional links, so the exclusion of I16#-18# because of TD simplex use has minimal impact.

Band Plan for I Band 404 - 430 MHz

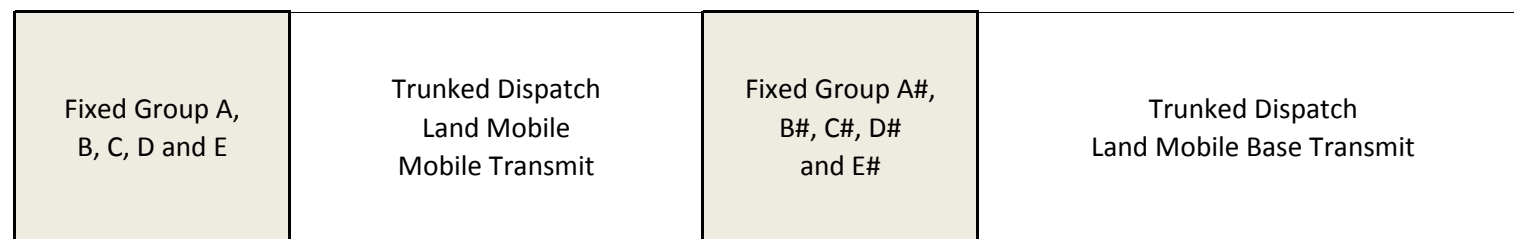

404

406

412

414

420

- Group A 8 x 75 kHz channels
- Group B 8 x 150 kHz channels
- Group C 4 x 100 kHz channels
- Group D 8 x 150 kHz channels
- Group E 8 x 75 kHz channels

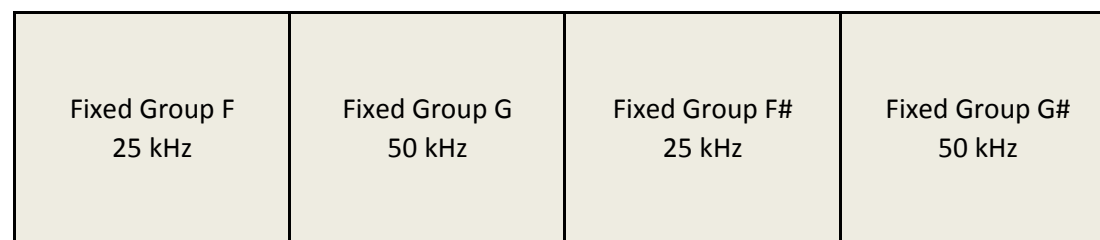

420

422.52

425

427.54

430

- Group F 101 x 25 kHz channels
- Group G 49 x 50 kHz channels

JL Band 440 - 449 MHz

Note: See Radio Licence Policy Rules (PIB 58) and Radio Licence Certification Rules (PIB 38). JL band is restricted for digital services only with a minimum spectral efficiency of 2 bits per second per Hertz (STL only channels are not subject to digital criteria).

12.5 kHz Channelling			
Channel	Frequency	Channel	Frequency
JL1A	440.01250	JL1A#	445.01875
JL2A	440.02500	JL2A#	445.03125
JL3A	440.03750	JL3A#	445.04375
JL4A	440.05000	JL4A#	445.05625
JL5A	440.06250	JL5A#	445.06875
JL6A	440.07500	JL6A#	445.08125
JL7A	440.08750	JL7A#	445.09375
JL8A	440.10000	JL8A#	445.10625
JL9A	440.11250	JL9A#	445.11875
JL10A	440.12500	JL10A#	445.13125
JL11A	440.13750	JL11A#	445.14375
JL12A	440.15000	JL12A#	445.15625
JL13A	440.16250	JL13A#	445.16875
JL14A	440.17500	JL14A#	445.18125
JL15A	440.18750	JL15A#	445.19375
JL16A	440.20000	JL16A#	445.20625
JL17A	440.21250	JL17A#	445.21875
JL18A	440.22500	JL18A#	445.23125
JL19A	440.23750	JL19A#	445.24375
JL20A	440.25000	JL20A#	445.25625
JL21A	440.26250	JL21A#	445.26875
JL22A	440.27500	JL22A#	445.28125
JL23A	440.28750	JL23A#	445.29375
JL24A	440.30000	JL24A#	445.30625
JL25A	440.31250	JL25A#	445.31875
JL26A	440.32500	JL26A#	445.33125
JL27A	440.33750	JL27A#	445.34375
JL28A	440.35000	JL28A#	445.35625
JL29A	440.36250	JL29A#	445.36875
JL30A	440.37500	JL30A#	445.38125
JL31A	440.38750	JL31A#	445.39375
JL32A	440.40000	JL32A#	445.40625
JL33A	440.41250	JL33A#	445.41875
JL34A	440.42500	JL34A#	445.43125
JL35A	440.43750	JL35A#	445.44375
JL36A	440.45000	JL36A#	445.45625
JL37A	440.46250	JL37A#	445.46875
JL38A	440.47500	JL38A#	445.48125
JL39A	440.48750	JL39A#	445.49375

12.5 kHz Channelling (continued)			
Channel	Frequency	Channel	Frequency
JL40A	440.50000	JL40A#	445.50625
JL41A	440.51250	JL41A#	445.51875
JL42A	440.52500	JL42A#	445.53125
JL43A	440.53750	JL43A#	445.54375
JL44A	440.55000	JL44A#	445.55625
JL45A	440.56250	JL45A#	445.56875
JL46A	440.57500	JL46A#	445.58125
JL47A	440.58750	JL47A#	445.59375
JL48A	440.60000	JL48A#	445.60625
JL49A	440.61250	JL49A#	445.61875
JL50A	440.62500	JL50A#	445.63125
JL51A	440.63750	JL51A#	445.64375
JL52A	440.65000	JL52A#	445.65625
JL53A	440.66250	JL53A#	445.66875
JL54A	440.67500	JL54A#	445.68125
JL55A	440.68750	JL55A#	445.69375
JL56A	440.70000	JL56A#	445.70625
JL57A	440.71250	JL57A#	445.71875
JL58A	440.72500	JL58A#	445.73125
JL59A	440.73750	JL59A#	445.74375
JL60A	440.75000	JL60A#	445.75625
JL61A	440.76250	JL61A#	445.76875
JL62A	440.77500	JL62A#	445.78125
JL63A	440.78750	JL63A#	445.79375
JL64A	440.80000	JL64A#	445.80625
JL65A	440.81250	JL65A#	445.81875
JL66A	440.82500	JL66A#	445.83125
JL67A	440.83750	JL67A#	445.84375
JL68A	440.85000	JL68A#	445.85625
JL69A	440.86250	JL69A#	445.86875
JL70A	440.87500	JL70A#	445.88125
JL71A	440.88750	JL71A#	445.89375
JL72A	440.90000	JL72A#	445.90625
JL73A	440.91250	JL73A#	445.91875
JL74A	440.92500	JL74A#	445.93125
JL75A	440.93750	JL75A#	445.94375
JL76A	440.95000	JL76A#	445.95625
JL77A	440.96250	JL77A#	445.96875
JL78A	440.97500	JL78A#	445.98125
JL79A	440.98750	JL79A#	445.99375
JL80A	441.00000	JL80A#	446.00625
JL81A	441.01250	JL81A#	446.01875
JL82A	441.02500	JL82A#	446.03125
JL83A	441.03750	JL83A#	446.04375
JL84A	441.05000	JL84A#	446.05625
JL85A	441.06250	JL85A#	446.06875
JL86A	441.07500	JL86A#	446.08125

12.5 kHz Channelling (continued)			
Channel	Frequency	Channel	Frequency
JL87A	441.08750	JL87A#	446.09375
JL88A	441.10000	JL88A#	446.10625
JL89A	441.11250	JL89A#	446.11875
JL90A	441.12500	JL90A#	446.13125
JL91A	441.13750	JL91A#	446.14375
JL92A	441.15000	JL92A#	446.15625
JL93A	441.16250	JL93A#	446.16875
JL94A	441.17500	JL94A#	446.18125
JL95A	441.18750	JL95A#	446.19375
JL96A	441.20000	JL96A#	446.20625
JL97A	441.21250	JL97A#	446.21875
JL98A	441.22500	JL98A#	446.23125
JL99A	441.23750	JL99A#	446.24375

25 kHz Channelling			
Channel	Frequency	Channel	Frequency
JL1B	441.26250	JL1B#	446.26875
JL2B	441.28750	JL2B#	446.29375
JL3B	441.31250	JL3B#	446.31875
JL4B	441.33750	JL4B#	446.34375
JL5B	441.36250	JL5B#	446.36875
JL6B	441.38750	JL6B#	446.39375
JL7B	441.41250	JL7B#	446.41875
JL8B	441.43750	JL8B#	446.44375
JL9B	441.46250	JL9B#	446.46875
JL10B	441.48750	JL10B#	446.49375
JL11B	441.51250	JL11B#	446.51875
JL12B	441.53750	JL12B#	446.54375
JL13B	441.56250	JL13B#	446.56875
JL14B	441.58750	JL14B#	446.59375
JL15B	441.61250	JL15B#	446.61875
JL16B	441.63750	JL16B#	446.64375
JL17B	441.66250	JL17B#	446.66875
JL18B	441.68750	JL18B#	446.69375
JL19B	441.71250	JL19B#	446.71875
JL20B	441.73750	JL20B#	446.74375
JL21B	441.76250	JL21B#	446.76875
JL22B	441.78750	JL22B#	446.79375
JL23B	441.81250	JL23B#	446.81875
JL24B	441.83750	JL24B#	446.84375
JL25B	441.86250	JL25B#	446.86875
JL26B	441.88750	JL26B#	446.89375
JL27B	441.91250	JL27B#	446.91875
JL28B	441.93750	JL28B#	446.94375
JL29B	441.96250	JL29B#	446.96875

25 kHz Channelling (continued)			
Channel	Frequency	Channel	Frequency
JL30B	441.98750	JL30B#	446.99375
JL31B	442.01250	JL31B#	447.01875
JL32B	442.03750	JL32B#	447.04375
JL33B	442.06250	JL33B#	447.06875
JL34B	442.08750	JL34B#	447.09375
JL35B	442.11250	JL35B#	447.11875
JL36B	442.13750	JL36B#	447.14375
JL37B	442.16250	JL37B#	447.16875
JL38B	442.18750	JL38B#	447.19375
JL39B	442.21250	JL39B#	447.21875
JL40B	442.23750	JL40B#	447.24375
JL41B	442.26250	JL41B#	447.26875
JL42B	442.28750	JL42B#	447.29375
JL43B	442.31250	JL43B#	447.31875
JL44B	442.33750	JL44B#	447.34375
JL45B	442.36250	JL45B#	447.36875
JL46B	442.38750	JL46B#	447.39375
JL47B	442.41250	JL47B#	447.41875
JL48B	442.43750	JL48B#	447.44375
JL49B	442.46250	JL49B#	447.46875
JL50B	442.48750	JL50B#	447.49375
JL51B	442.51250	JL51B#	447.51875
JL52B	442.53750	JL52B#	447.54375
JL53B	442.56250	JL53B#	447.56875
JL54B	442.58750	JL54B#	447.59375
JL55B	442.61250	JL55B#	447.61875
JL56B	442.63750	JL56B#	447.64375
JL57B	442.66250	JL57B#	447.66875
JL58B	442.68750	JL58B#	447.69375
JL59B	442.71250	JL59B#	447.71875
JL60B	442.73750	JL60B#	447.74375
JL61B	442.76250	JL61B#	447.76875
JL62B	442.78750	JL62B#	447.79375
JL63B	442.81250	JL63B#	447.81875
JL64B	442.83750	JL64B#	447.84375
JL65B	442.86250	JL65B#	447.86875
JL66B	442.88750	JL66B#	447.89375
JL67B	442.91250	JL67B#	447.91875
JL68B	442.93750	JL68B#	447.94375
JL69B	442.96250	JL69B#	447.96875

50 kHz Channelling			
Channel	Frequency	Channel	Frequency
JL1C	443.02500	JL1C#	448.03125
JL2C	443.07500	JL2C#	448.08125
JL3C	443.12500	JL3C#	448.13125
JL4C	443.17500	JL4C#	448.18125
JL5C	443.22500	JL5C#	448.23125
JL6C	443.27500	JL6C#	448.28125
JL7C	443.32500	JL7C#	448.33125
JL8C	443.37500	JL8C#	448.38125
JL9C	443.42500	JL9C#	448.43125
JL10C	443.47500	JL10C#	448.48125
JL11C	443.52500	JL11C#	448.53125
JL12C	443.57500	JL12C#	448.58125
JL13C	443.62500	JL13C#	448.63125
JL14C	443.67500	JL14C#	448.68125
JL15C	443.72500	JL15C#	448.73125
JL16C	443.77500	JL16C#	448.78125
JL17C	443.82500	JL17C#	448.83125
JL18C	443.87500	JL18C#	448.88125
JL19C	443.92500	JL19C#	448.93125

75 kHz Channelling	
Channel	Frequency
JL1D	444.03750
JL2D	444.11250
JL3D	444.18750
JL4D	444.26250

150 kHz Channelling	
Channel	Frequency
JL1E	444.67500
JL2E	444.82500

300 kHz Channelling	
Channel	Frequency
JL1F	444.45000

Note: The 75, 150, and 300 kHz channels are for Studio to Transmitter Linking only. See Radio Licence Policy Rules (PIB 58) and Radio Licence Certification Rules (PIB 38).

Band Plan for JL Band 440 - 449 MHz

440.00 441.25 443.00 444.00 444.30 444.60 445.00 446.25 448.00 449.00

Group A 12.5 kHz Channels	Group B 25 kHz Channels	Group C 50 kHz Channels	Group D 75 kHz Channels	Group F 300 kHz Channels	Group E 150 kHz Channels	Group A# 12.5 kHz Channels	Group B# 25 kHz Channels	Group C# 50 kHz Channels
---------------------------------	-------------------------------	-------------------------------	-------------------------------	--------------------------------	--------------------------------	----------------------------------	--------------------------------	--------------------------------



STL only

J Band 450 - 470 MHz

12.5 kHz Channelling			
Channel	Frequency	Channel	Frequency
JNB1	453.63125	JNB1#	458.66875
JNB2	453.64375	JNB2#	458.68125
JNB3	453.65625	JNB3#	458.69375
JNB4	453.66875	JNB4#	458.70625
JNB5	453.68125	JNB5#	458.71875
JNB6	453.69375	JNB6#	458.73125
JNB7	453.70625	JNB7#	458.74375
JNB8	453.71875	JNB8#	458.75625
JNB9	453.73125	JNB9#	458.76875
JNB10	453.74375	JNB10#	458.78125
JNB11	453.75625	JNB11#	458.79375
JNB12	453.76875	JNB12#	458.80625
JNB13	453.78125	JNB13#	458.81875
JNB14	453.79375	JNB14#	458.83125
JNB15	453.80625	JNB15#	458.84375
JNB16	453.81875	JNB16#	458.85625
JNB17	453.83125	JNB17#	458.86875
JNB18	453.84375	JNB18#	458.88125
JNB19	453.85625	JNB19#	458.89375
JNB20	453.86875	JNB20#	458.90625
JNB21	453.88125	JNB21#	458.91875
JNB22	453.89375	JNB22#	458.93125
JNB23	453.90625	JNB23#	458.94375
JNB24	453.91875	JNB24#	458.95625
JNB25	453.93125	JNB25#	458.96875
JNB26	453.94375	JNB26#	458.98125
JNB27	453.95625	JNB27#	458.99375
JNB28	453.96875	JNB28#	459.00625
JNB29	453.98125	JNB29#	459.01875
JNB30	453.99375	JNB30#	459.03125
JNB31	454.00625	JNB31#	459.04375
JNB32	454.01875	JNB32#	459.05625
JNB33	454.03125	JNB33#	459.06875
JNB34	454.04375	JNB34#	459.08125
JNB35	454.05625	JNB35#	459.09375
JNB36	454.06875	JNB36#	459.10625
JNB37	454.08125	JNB37#	459.11875
JNB38	454.09375	JNB38#	459.13125
JNB39	454.10625	JNB39#	459.14375
JNB40	454.11875	JNB40#	459.15625
JNB41	454.13125	JNB41#	459.16875
JNB42	454.14375	JNB42#	459.18125
JNB43	454.15625	JNB43#	459.19375
JNB44	454.16875	JNB44#	459.20625

12.5 kHz Channelling (continued)			
Channel	Frequency	Channel	Frequency
JNB45	454.18125	JNB45#	459.21875
JNB46	454.19375	JNB46#	459.23125
JNB47	454.20625	JNB47#	459.24375
JNB48	454.21875	JNB48#	459.25625
JNB49	454.23125	JNB49#	459.26875
JNB50	454.24375	JNB50#	459.28125
JNB51	454.25625	JNB51#	459.29375
JNB52	454.26875	JNB52#	459.30625
JNB53	454.28125	JNB53#	459.31875
JNB54	454.29375	JNB54#	459.33125
JNB55	454.30625	JNB55#	459.34375
JNB56	454.31875	JNB56#	459.35625
JNB57	454.33125	JNB57#	459.36875
JNB58	454.34375	JNB58#	459.38125
JNB59	454.35625	JNB59#	459.39375
JNB60	454.36875	JNB60#	459.40625
JNB61	454.38125	JNB61#	459.41875
JNB62	454.39375	JNB62#	459.43125
JNB63	454.40625	JNB63#	459.44375
JNB64	454.41875	JNB64#	459.45625
JNB65	454.43125	JNB65#	459.46875
JNB66	454.44375	JNB66#	459.48125
JNB67	454.45625	JNB67#	459.49375
JNB68	454.46875	JNB68#	459.50625
JNB69	454.48125	JNB69#	459.51875
JNB70	454.49375	JNB70#	459.53125
JNB71	454.50625	JNB71#	459.54375
JNB72	454.51875	JNB72#	459.55625
JNB73	454.53125	JNB73#	459.56875
JNB74	454.54375	JNB74#	459.58125
JNB75	454.55625	JNB75#	459.59375
JNB76	454.56875	JNB76#	459.60625
JNB77	454.58125	JNB77#	459.61875
JNB78	454.59375	JNB78#	459.63125
JNB79	454.60625	JNB79#	459.64375
JNB80	454.61875	JNB80#	459.65625
JNB81	454.63125	JNB81#	459.66875
JNB82	454.64375	JNB82#	459.68125
JNB83	454.65625	JNB83#	459.69375
JNB84	454.66875	JNB84#	459.70625
JNB85	454.68125	JNB85#	459.71875
JNB86	454.69375	JNB86#	459.73125
JNB87	454.70625	JNB87#	459.74375
JNB88	454.71875	JNB88#	459.75625
JNB89	454.73125	JNB89#	459.76875
JNB90	454.74375	JNB90#	459.78125
JNB91	454.75625	JNB91#	459.79375

12.5 kHz Channelling (continued)			
Channel	Frequency	Channel	Frequency
JNB92	454.76875	JNB92#	459.80625
JNB93	454.78125	JNB93#	459.81875
JNB94	454.79375	JNB94#	459.83125
JNB95	454.80625	JNB95#	459.84375
JNB96	454.81875	JNB96#	459.85625
JNB97	454.83125	JNB97#	459.86875
JNB98	454.84375	JNB98#	459.88125
JNB99	454.85625	JNB99#	459.89375
JNB100	454.86875	JNB100#	459.90625
JNB101	454.88125	JNB101#	459.91875
JNB102	454.89375	JNB102#	459.93125
JNB103	454.90625	JNB103#	459.94375
JNB104	454.91875	JNB104#	459.95625
JNB105	454.93125	JNB105#	459.96875
JNB106	454.94375	JNB106#	459.98125
JNB107	454.95625	JNB107#	459.99375
JNB108	454.96875	JNB108#	460.00625

25 kHz Channelling			
Channel	Frequency	Channel	Frequency
J1B	453.65000	J1B#	458.68750
J2B	453.67500	J2B#	458.71250
J3B	453.70000	J3B#	458.73750
J4B	453.72500	J4B#	458.76250
J5B	453.75000	J5B#	458.78750
J6B	453.77500	J6B#	458.81250
J7B	453.80000	J7B#	458.83750
J8B	453.82500	J8B#	458.86250
J9B	453.85000	J9B#	458.88750
J10B	453.87500	J10B#	458.91250
J11B	453.90000	J11B#	458.93750
J12B	453.92500	J12B#	458.96250
J13B	453.95000	J13B#	458.98750
J14B	453.97500	J14B#	459.01250
J15B	454.00000	J15B#	459.03750
J16B	454.02500	J16B#	459.06250
J17B	454.05000	J17B#	459.08750
J18B	454.07500	J18B#	459.11250
J19B	454.10000	J19B#	459.13750
J20B	454.12500	J20B#	459.16250
J21B	454.15000	J21B#	459.18750
J22B	454.17500	J22B#	459.21250
J23B	454.20000	J23B#	459.23750
J24B	454.22500	J24B#	459.26250
J25B	454.25000	J25B#	459.28750

25 kHz Channelling (continued)			
Channel	Frequency	Channel	Frequency
J26B	454.27500	J26B#	459.31250
J27B	454.30000	J27B#	459.33750
J28B	454.32500	J28B#	459.36250
J29B	454.35000	J29B#	459.38750
J30B	454.37500	J30B#	459.41250
J31B	454.40000	J31B#	459.43750
J32B	454.42500	J32B#	459.46250
J33B	454.45000	J33B#	459.48750
J34B	454.47500	J34B#	459.51250
J35B	454.50000	J35B#	459.53750
J36B	454.52500	J36B#	459.56250
J37B	454.55000	J37B#	459.58750
J38B	454.57500	J38B#	459.61250
J39B	454.60000	J39B#	459.63750
J40B	454.62500	J40B#	459.66250
J41B	454.65000	J41B#	459.68750
J42B	454.67500	J42B#	459.71250
J43B	454.70000	J43B#	459.73750
J44B	454.72500	J44B#	459.76250
J45B	454.75000	J45B#	459.78750
J46B	454.77500	J46B#	459.81250
J47B	454.80000	J47B#	459.83750
J48B	454.82500	J48B#	459.86250
J49B	454.85000	J49B#	459.88750
J50B	454.87500	J50B#	459.91250
J51B	454.90000	J51B#	459.93750
J52B	454.92500	J52B#	459.96250
J53B	454.95000	J53B#	459.98750

50 kHz Channelling			
Channel	Frequency	Channel	Frequency
J101D	460.05000	J101D#	465.26250
J102D	460.10000	J102D#	465.31250
J103D	460.15000	J103D#	465.36250
J104D	460.20000	J104D#	465.41250
J105D	460.25000	J105D#	465.46250
J106D	460.30000	J106D#	465.51250
J107D	460.35000	J107D#	465.56250
J108D	460.40000	J108D#	465.61250
J109D	460.45000	J109D#	465.66250
J110D	460.50000	J110D#	465.71250
J111D	460.55000	J111D#	465.76250
J112D	460.60000	J112D#	465.81250
J113D	460.65000	J113D#	465.86250
J114D	460.70000	J114D#	465.91250

50 kHz Channelling (continued)			
Channel	Frequency	Channel	Frequency
J115D	460.75000	J115D#	465.96250
J116D	460.80000	J116D#	466.01250
J117D	460.85000	J117D#	466.06250
J118D	460.90000	J118D#	466.11250
J119D	460.95000	J119D#	466.16250
J120D	461.00000	J120D#	466.21250
J121D	461.05000	J121D#	466.26250
J122D	461.10000	J122D#	466.31250
J123D	461.15000	J123D#	466.36250
J124D	461.20000	J124D#	466.41250
J125D	461.25000	J125D#	466.46250
J126D	461.30000	J126D#	466.51250
J127D	461.35000	J127D#	466.56250
J128D	461.40000	J128D#	466.61250

12.5 kHz Channelling	
Channel	Frequency
JBX1	449.38125
JBX2	449.39375
JBX3	449.40625
JBX4	449.41875
JBX5	449.43125
JBX6	449.44375
JBX7	449.45625
JBX8	449.46875
JBX9	449.48125
JBX10	449.49375
JBX11	449.50625
JBX12	449.51875
JBX13	449.53125
JBX14	449.54375
JBX15	449.55625
JBX16	449.56875
JBX17	449.58125
JBX18	449.59375
JBX19	449.60625
JBX20	449.61875
JBX21	449.63125
JBX22	449.64375
JBX23	449.65625
JBX24	449.66875
JBX25	449.68125
JBX26	449.69375
JBX27	449.70625

12.5 kHz Channelling (continued)	
Channel	Frequency
JBX28	449.71875
JBX29	449.73125
JBX30	449.74375

25 kHz Channelling	
Channel	Frequency
J54C	450.01250
J55C	450.03750
J56C	450.06250
J57C	450.08750
J58C	450.11250
J59C	450.13750
J60C	450.16250
J61C	450.18750
J62C	450.21250
J63C	450.23750
J64C	450.26250

50 kHz Channelling	
Channel	Frequency
J129E	461.45000
J130F	465.21250

Band Plan for J Band 450 - 470 MHz

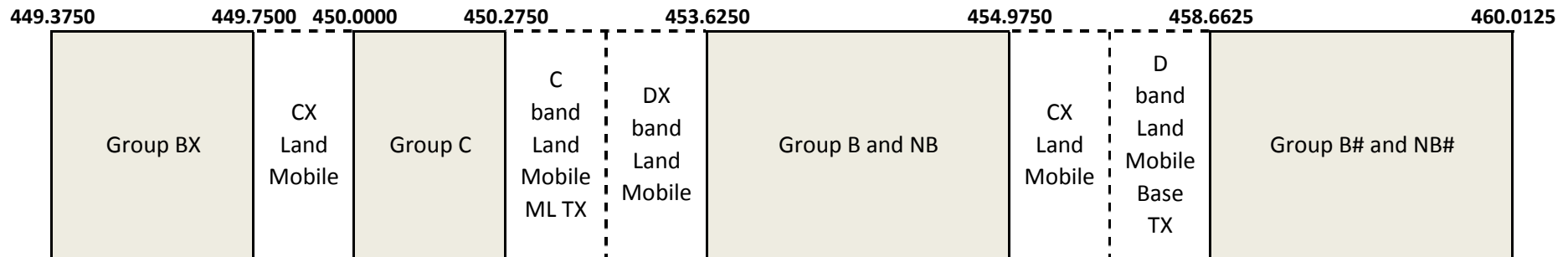

- Group BX 30 x 12.5 kHz simplex channels
- Group C 11 x 25 kHz simplex channels
- Group B 53 x 25 kHz channels
- Group NB 108 x 12.5 kHz channels

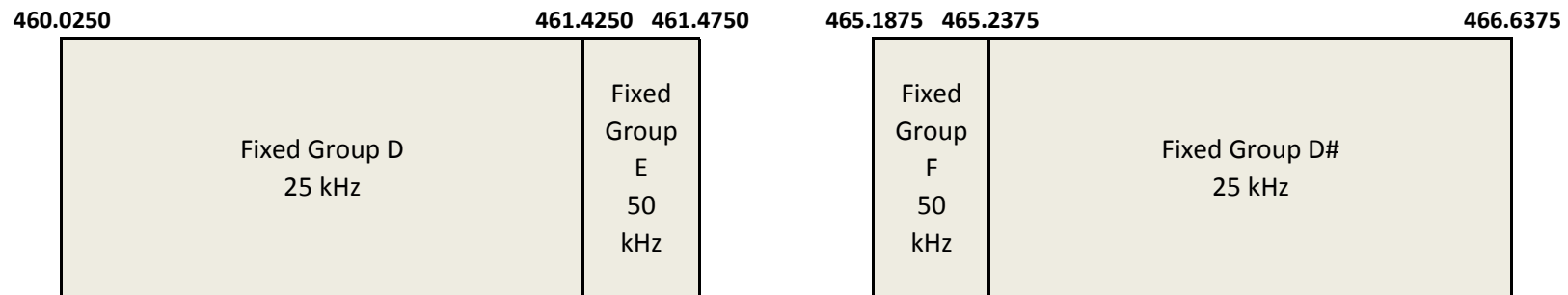

- Group D 28 x 50 kHz channels
- Groups E and F 2 x 50 kHz channels

KL Band 841 - 851 MHz

Note: This band is restricted for Studio to Transmitter Linking only.
See Radio Licence Policy Rules (PIB 58) and Radio Licence Certification Rules (PIB 38).

250 kHz Channelling (Monophonic services)	
Channel	Frequency
KLA1	841.125
KLB1	841.375
KLA2	841.625
KLB2	841.875
KLA3	842.125
KLB3	842.375
KLA4	842.625
KLB4	842.875
KLA5	843.125
KLB5	843.375
KLA6	843.625
KLB6	843.875
KLA7	844.125
KLB7	844.375
KLA8	844.625
KLB8	844.875
KLA9	845.125
KLB9	845.375
KLA10	845.625
KLB10	845.875
KLA11	846.125
KLB11	846.375
KLA12	846.625
KLB12	846.875
KLA13	847.125
KLB13	847.375
KLA14	847.625
KLB14	847.875
KLA15	848.125
KLB15	848.375
KLA16	848.625
KLB16	848.875
KLA17	849.125
KLB17	849.375
KLA18	849.625
KLB18	849.875
KLA19	850.125
KLB19	850.375
KLA20	850.625
KLB20	850.875

500 kHz Channelling (Composite stereophonic services)	
Channel	Frequency
KL1	841.25
KL2	841.75
KL3	842.25
KL4	842.75
KL5	843.25
KL6	843.75
KL7	844.25
KL8	844.75
KL9	845.25
KL10	845.75
KL11	846.25
KL12	846.75
KL13	847.25
KL14	847.75
KL15	848.25
KL16	848.75
KL17	849.25
KL18	849.75
KL19	850.25
KL20	850.75

Band Plan for KL Band 841 - 851 MHz

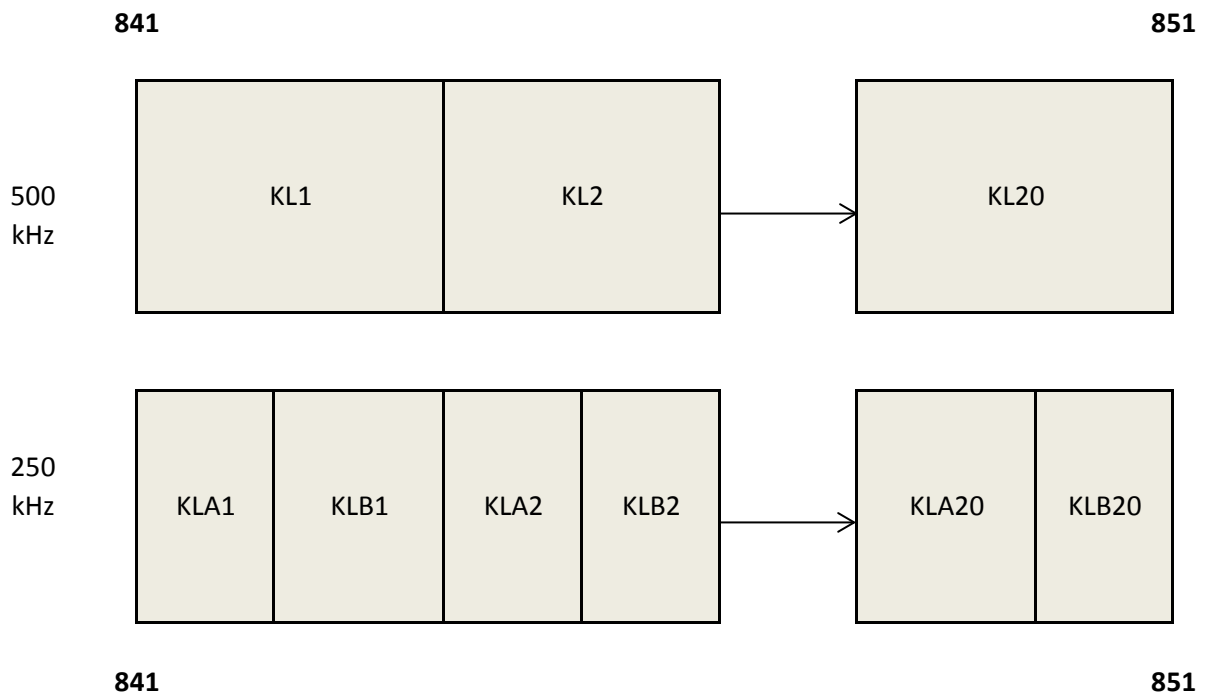

Channelling: 250 or 500 kHz

KK Band 806 - 812 / 851 - 857 MHz

Note: The KK band is restricted for digital linking only.

500 kHz Channelling			
Channel	Frequency	Channel	Frequency
KK1	806.2500	KK1#	851.2500
KK2	806.7500	KK2#	851.7500
KK3	807.2500	KK3#	852.2500
KK4	807.7500	KK4#	852.7500
KK5	808.2500	KK5#	853.2500
KK6	808.7500	KK6#	853.7500
KK7	809.2500	KK7#	854.2500
KK8	809.7500	KK8#	854.7500
KK9	810.2500	KK9#	855.2500
KK10	810.7500	KK10#	855.7500
KK11	811.2500	KK11#	856.2500
KK12	811.7500	KK12#	856.7500

Band Plan for KK Band 806 - 812/851 - 857 MHz

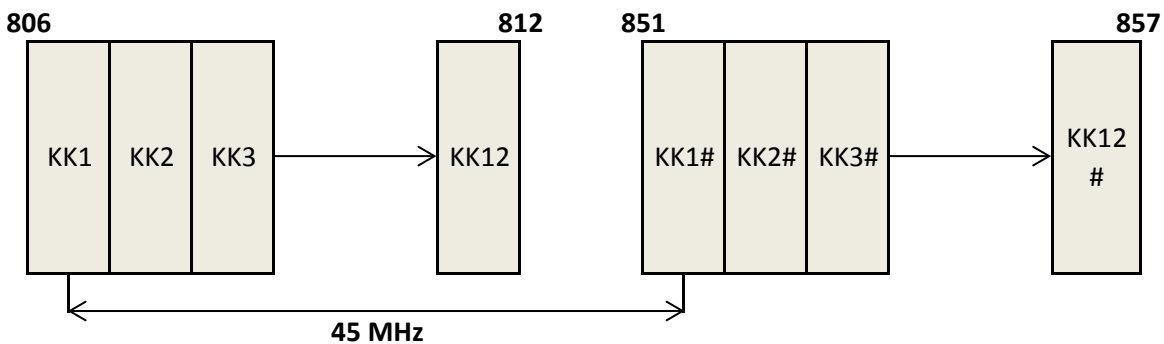

Channelling: 500 kHz

K Band 915 - 935 MHz

Note: This band is restricted for Studio to Transmitter Linking only.

There is a moratorium in place on the K band channels (915 – 921 MHz) where no new licenses are permitted. Channels in the 928 – 929 MHz range (highlighted in grey) are reserved for the transition from the 915 - 921 MHz band. See Radio Licence Policy Rules (PIB 58) and Radio Licence Certification Rules (PIB 38).

250 kHz Channelling (Monophonic services)	
Channel	Frequency
K1B1	915.1250
K1B2	915.3750
K1B3	915.6250
K1B4	915.8750
K2B1	916.1250
K2B2	916.3750
K2B3	916.6250
K2B4	916.8750
K3B1	917.1250
K3B2	917.3750
K3B3	917.6250
K3B4	917.8750
K4B1	918.1250
K4B2	918.3750
K4B3	918.6250
K4B4	918.8750
K5B1	919.1250
K5B2	919.3750
K5B3	919.6250
K5B4	919.8750
K6B1	920.1250
K6B2	920.3750
K6B3	920.6250
K6B4	920.8750
K0B1#	928.1250
K0B2#	928.3750
K0B3#	928.6250
K0B4#	928.8750
K1B1#	929.1250
K1B2#	929.3750
K1B3#	929.6250
K1B4#	929.8750
K2B1#	930.1250
K2B2#	930.3750
K2B3#	930.6250
K2B4#	930.8750
K3B1#	931.1250
K3B2#	931.3750
K3B3#	931.6250

250 kHz Channelling (Monophonic) (cntd.)	
Channel	Frequency
K3B4#	931.8750
K4B1#	932.1250
K4B2#	932.3750
K4B3#	932.6250
K4B4#	932.8750
K5B1#	933.1250
K5B2#	933.3750
K5B3#	933.6250
K5B4#	933.8750
K6B1#	934.1250
K6B2#	934.3750
K6B3#	934.6250
K6B4#	934.8750

500 kHz Channelling (Composite stereophonic services)	
Channel	Frequency
K1A1	915.2500
K1A2	915.7500
K2A1	916.2500
K2A2	916.7500
K3A1	917.2500
K3A2	917.7500
K4A1	918.2500
K4A2	918.7500
K5A1	919.2500
K5A2	919.7500
K6A1	920.2500
K6A2	920.7500
K0A1#	928.2500
K0A2#	928.7500
K1A1#	929.2500
K1A2#	929.7500
K2A1#	930.2500
K2A2#	930.7500
K3A1#	931.2500
K3A2#	931.7500
K4A1#	932.2500
K4A2#	932.7500
K5A1#	933.2500
K5A2#	933.7500
K6A1#	934.2500
K6A2#	934.7500

Band Plan for K Band 915 - 921 / 929 - 935 MHz

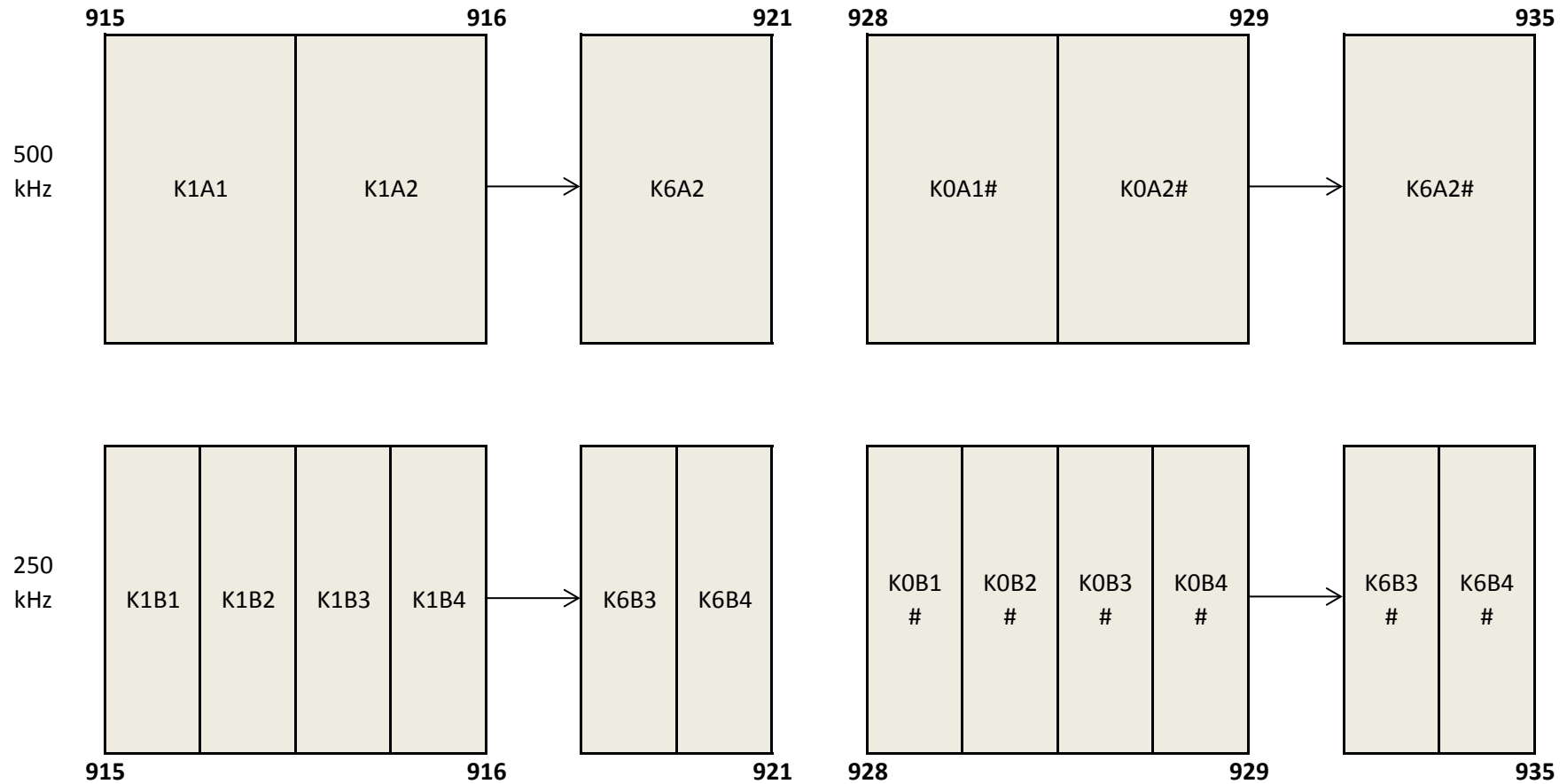

Channelling: 250 or 500 kHz

LL Band 1427 –1525 MHz

Note: See Radio Licence Policy Rules (PIB 58) and Radio Licence Certification Rules (PIB 38).

75 kHz Channelling			
Channel	Frequency	Channel	Frequency
LL75/1	1427.5375	LL75/1#	1522.0375
LL75/2	1427.6125	LL75/2#	1522.1125
LL75/3	1427.6875	LL75/3#	1522.1875
LL75/4	1427.7625	LL75/4#	1522.2625
LL75/5	1427.8375	LL75/5#	1522.3375
LL75/6	1427.9125	LL75/6#	1522.4125
LL75/7	1427.9875	LL75/7#	1522.4875
LL75/8	1428.0625	LL75/8#	1522.5625
LL75/9	1428.1375	LL75/9#	1522.6375
LL75/10	1428.2125	LL75/10#	1522.7125
LL75/11	1428.2875	LL75/11#	1522.7875
LL75/12	1428.3625	LL75/12#	1522.8625
LL75/13	1428.4375	LL75/13#	1522.9375
LL75/14	1428.5125	LL75/14#	1523.0125
LL75/15	1428.5875	LL75/15#	1523.0875
LL75/16	1428.6625	LL75/16#	1523.1625
LL75/17	1428.7375	LL75/17#	1523.2375
LL75/18	1428.8125	LL75/18#	1523.3125
LL75/19	1428.8875	LL75/19#	1523.3875
LL75/20	1428.9625	LL75/20#	1523.4625
LL75/21	1429.0375	LL75/21#	1523.5375
LL75/22	1429.1125	LL75/22#	1523.6125
LL75/23	1429.1875	LL75/23#	1523.6875
LL75/24	1429.2625	LL75/24#	1523.7625
LL75/25	1429.3375	LL75/25#	1523.8375
LL75/26	1429.4125	LL75/26#	1523.9125

150 kHz Channelling			
Channel	Frequency	Channel	Frequency
LL150/1	1427.5750	LL150/1#	1522.0750
LL150/2	1427.7250	LL150/2#	1522.2250
LL150/3	1427.8750	LL150/3#	1522.3750
LL150/4	1428.0250	LL150/4#	1522.5250
LL150/5	1428.1750	LL150/5#	1522.6750
LL150/6	1428.3250	LL150/6#	1522.8250
LL150/7	1428.4750	LL150/7#	1522.9750
LL150/8	1428.6250	LL150/8#	1523.1250
LL150/9	1428.7750	LL150/9#	1523.2750
LL150/10	1428.9250	LL150/10#	1523.4250
LL150/11	1429.0750	LL150/11#	1523.5750
LL150/12	1429.2250	LL150/12#	1523.7250
LL150/13	1429.3750	LL150/13#	1523.8750

250 kHz Channelling			
Channel	Frequency	Channel	Frequency
LL250/1	1427.6250	LL250/1#	1522.1250
LL250/2	1427.8750	LL250/2#	1522.3750
LL250/3	1428.1250	LL250/3#	1522.6250
LL250/4	1428.3750	LL250/4#	1522.8750
LL250/5	1428.6250	LL250/5#	1523.1250
LL250/6	1428.8750	LL250/6#	1523.3750
LL250/7	1429.1250	LL250/7#	1523.6250
LL250/8	1429.3750	LL250/8#	1523.8750

Band Plan for LL Band 1427 - 1525 MHz

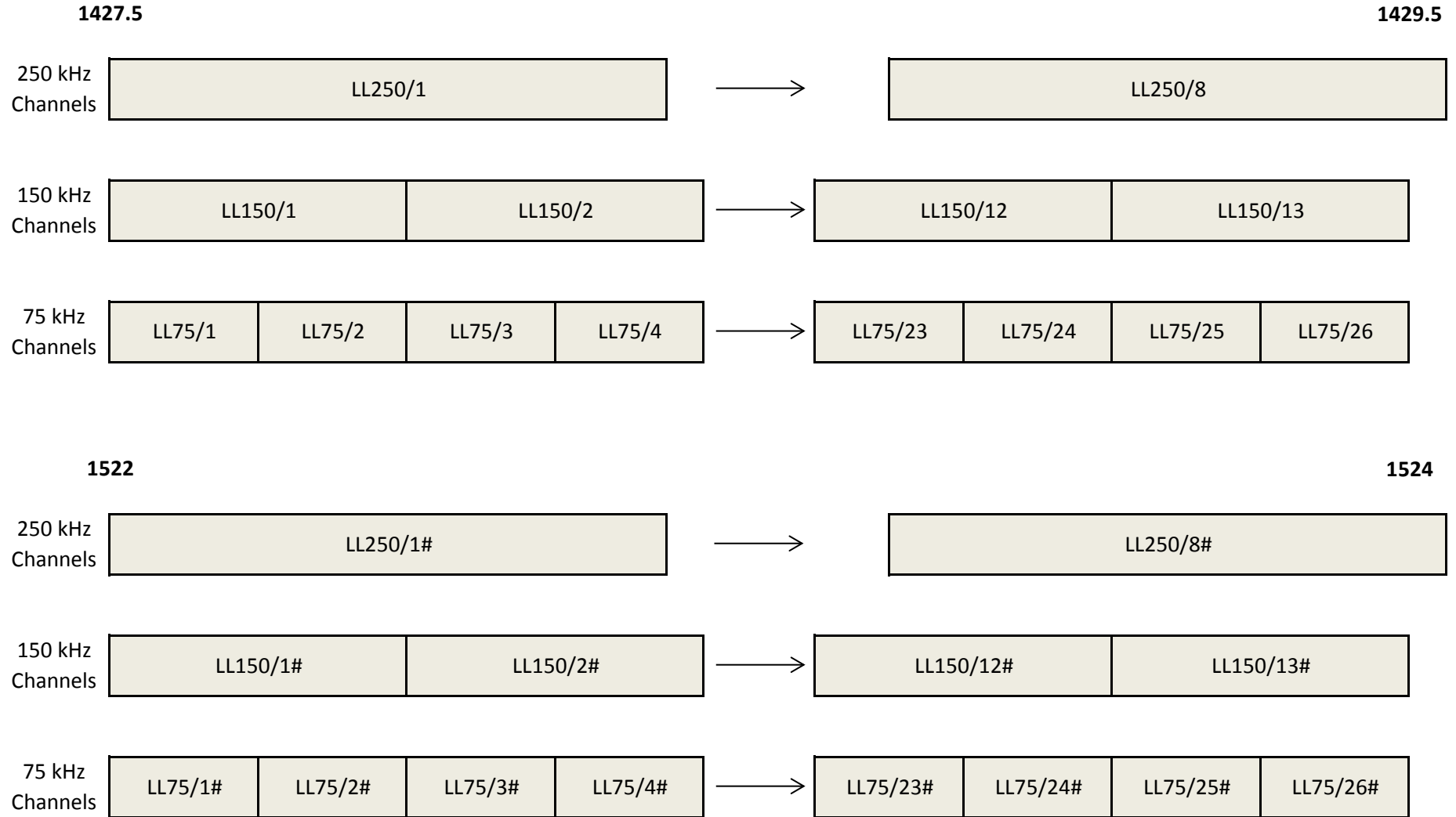

L Band 1427 - 1525 MHz

4 MHz Channelling			
Channel	Frequency	Channel	Frequency
L102	1431.500	L102#	1492.000
L304	1435.500	L304#	1496.000
L506	1439.500	L506#	1500.000
L708	1443.500	L708#	1504.000
L910	1447.500	L910#	1508.000
L112	1451.500	L112#	1512.000
L314	1455.500	L314#	1516.000
L516	1459.500	L516#	1520.000

2 MHz Channelling			
Channel	Frequency	Channel	Frequency
L1	1430.500	L1#	1491.000
L2	1432.500	L2#	1493.000
L3	1434.500	L3#	1495.000
L4	1436.500	L4#	1497.000
L5	1438.500	L5#	1499.000
L6	1440.500	L6#	1501.000
L7	1442.500	L7#	1503.000
L8	1444.500	L8#	1505.000
L9	1446.500	L9#	1507.000
L10	1448.500	L10#	1509.000
L11	1450.500	L11#	1511.000
L12	1452.500	L12#	1513.000
L13	1454.500	L13#	1515.000
L14	1456.500	L14#	1517.000
L15	1458.500	L15#	1519.000
L16	1460.500	L16#	1521.000

Band Plan for L Band 1427 - 1525 MHz

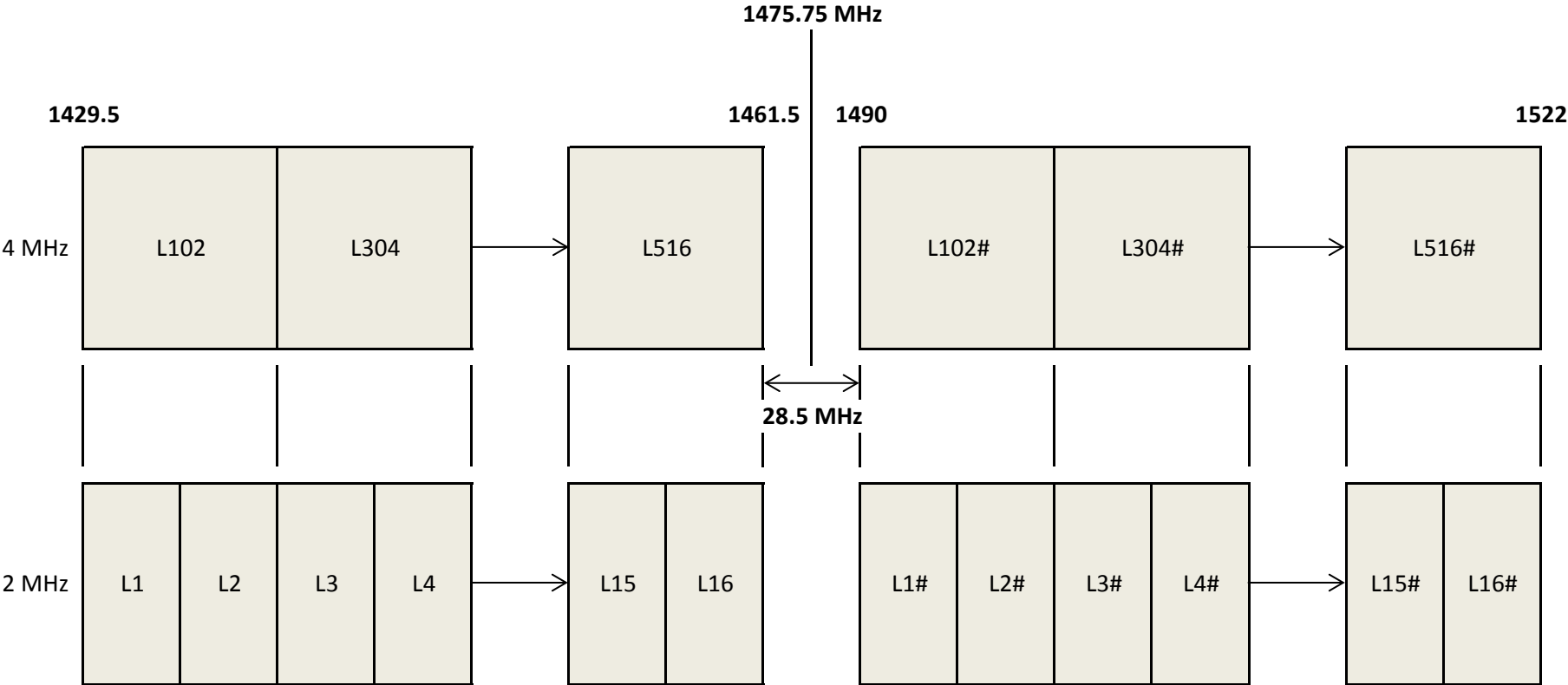

Channelling: 2 and 4 MHz

2G8 Band 2700 - 2900 MHz

Note: See Radio Licence Policy Rules (PIB 58) and Radio Licence Certification Rules (PIB 38). This band is designated for itinerant point-to-point linking for Television outside broadcasting (TVOB).

Channelling: 28 and 10 MHz
 Typical Use: Video linking

TVOB 28 MHz Channelling	
Channel	Frequency
2G81	2720.000
2G82	2750.000
2G83	2780.000
2G81#	2820.000
2G82#	2850.000
2G83#	2880.000

TVOB 10 MHz Channelling	
Channel	Frequency
2G81A	2710.000
2G81B	2720.000
2G81C	2730.000
2G82A	2740.000
2G82B	2750.000
2G82C	2760.000
2G83A	2770.000
2G83B	2780.000
2G83C	2790.000
2G83D	2800.000
2G81A#	2810.000
2G81B#	2820.000
2G81C#	2830.000
2G82A#	2840.000
2G82B#	2850.000
2G82C#	2860.000
2G83A#	2870.000
2G83B#	2880.000
2G83C#	2890.000

Band Plan for 2G8 Band 2700 - 2900 MHz

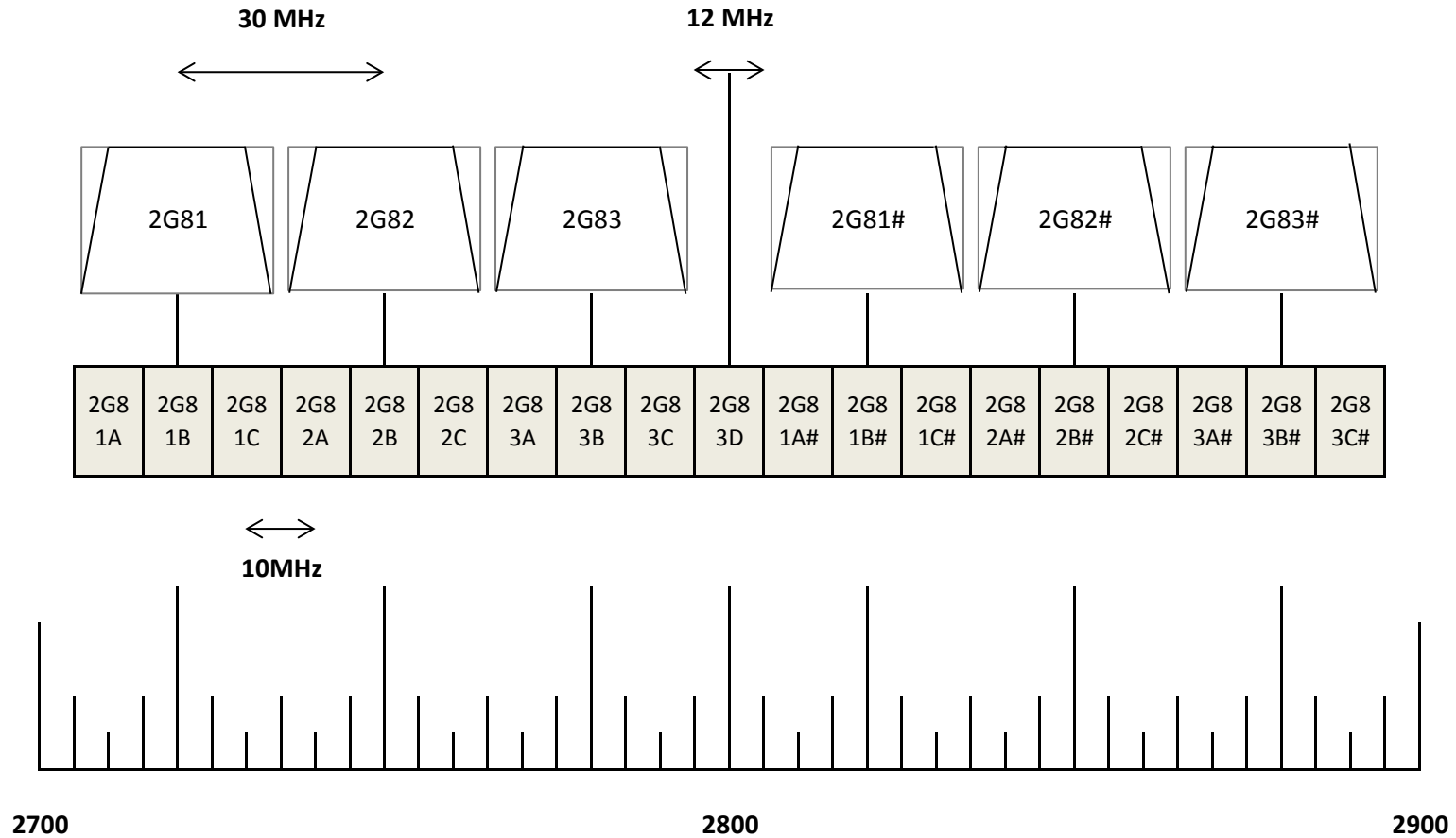

Channelling: 10 and 28 MHz

4 GHz Band 3600 - 4200 MHz

This band is designated for use by high capacity fixed point-to-point links. See Radio Licence Policy Rules (PIB 58) and Radio Licence Certification Rules (PIB 38).

Note: Proposed links need to be co-ordinated with satellite earth stations operating in this band.

40 MHz Channelling			
Channel	Frequency	Channel	Frequency
4G1	3650.000	4G1#	3950.000
4G2	3690.000	4G2#	3990.000
4G3	3730.000	4G3#	4030.000
4G4	3770.000	4G4#	4070.000
4G5	3810.000	4G5#	4110.000
4G6	3850.000	4G6#	4150.000

Band Plan for 4 GHz Band 3600 - 4200 MHz

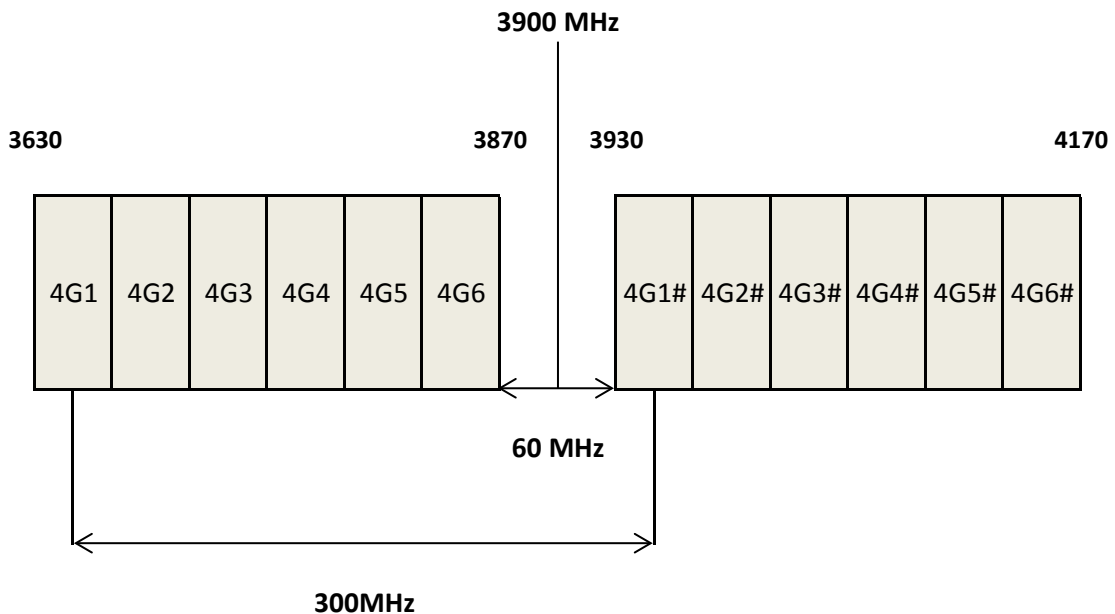

Channelling: 40 MHz

Coordination is required between satellite and terrestrial services that share this band.

5 GHz Band 4400 - 5000 MHz

Note: See Radio Licence Policy Rules (PIB 58) and Radio Licence Certification Rules (PIB 38). This band is designated for use by digital high capacity fixed point-to-point links.

Note: Proposed links need to be co-ordinated with satellite Earth stations operating in this band.

40 MHz Channelling			
Channel	Frequency	Channel	Frequency
5G1	4430.000	5G1#	4730.000
5G2	4470.000	5G2#	4770.000
5G3	4510.000	5G3#	4810.000
5G4	4550.000	5G4#	4850.000
5G5	4590.000	5G5#	4890.000
5G6	4630.000	5G6#	4930.000
5G7	4670.000	5G7#	4970.000

Band Plan for 5 GHz Band 4400 - 5000 MHz

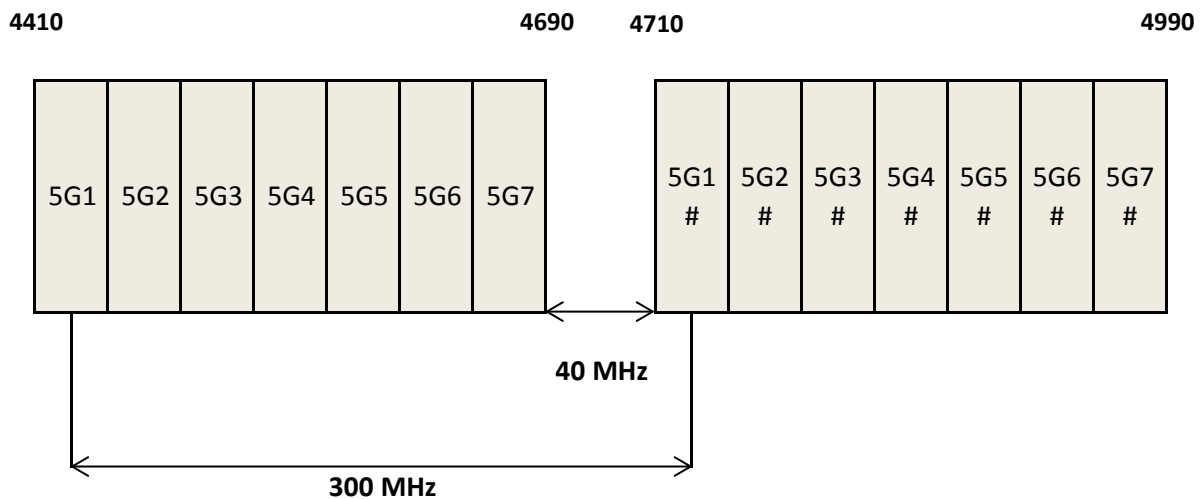

Channelling: 40 MHz

6 GHz Band 5925 - 6420 MHz

This band is designated for use by digital high capacity fixed point-to-point links.

29.65 MHz Channelling			
Channel	Frequency	Channel	Frequency
6G1	5945.200	6G1#	6197.240
6G2	5974.850	6G2#	6226.890
6G3	6004.500	6G3#	6256.540
6G4	6034.150	6G4#	6286.190
6G5	6063.800	6G5#	6315.840
6G6	6093.450	6G6#	6345.490
6G7	6123.100	6G7#	6375.140
6G8	6152.750	6G8#	6404.790

Note: 6 GHz band usage must be coordinated with satellite services.

Band Plan for 6 GHz Band 5925 - 6420 MHz

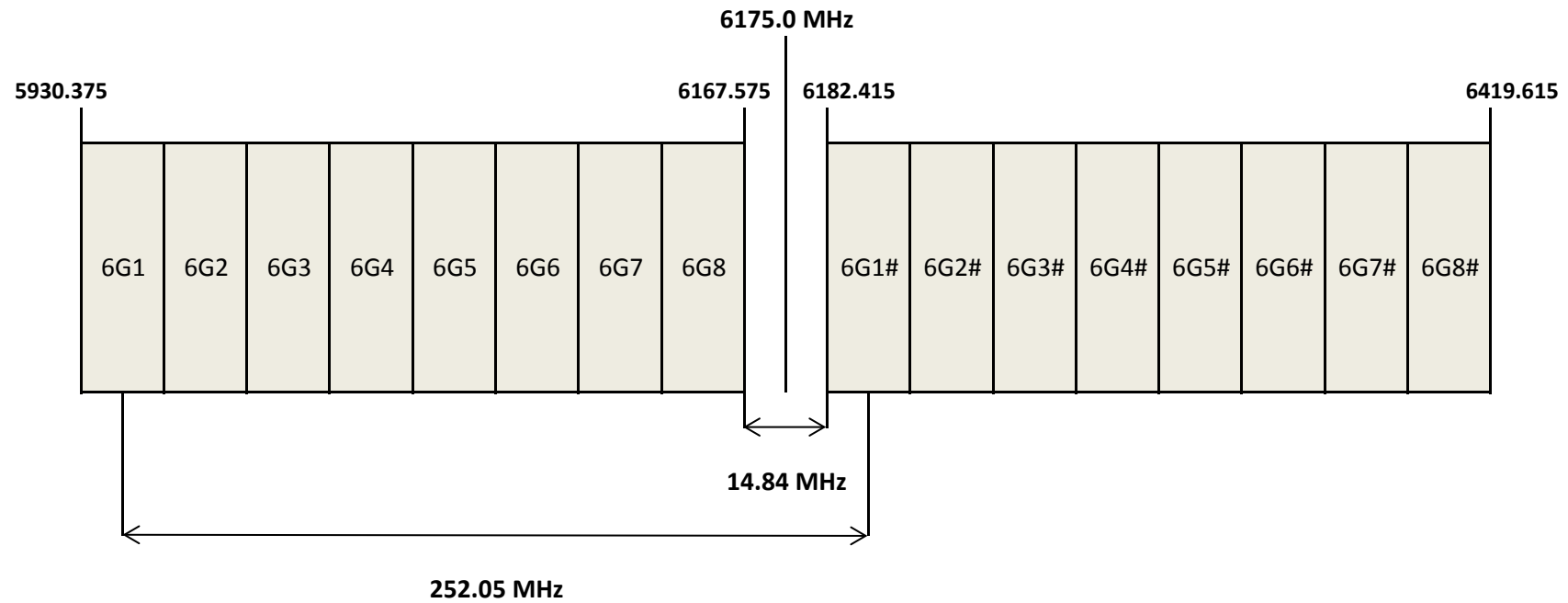

Channelling: 29.65 MHz

Coordination is required between satellite and terrestrial services that share this band.

7 GHz (Lower) Band 6420 - 7100 MHz

This band is designated for use by digital high capacity fixed point-to-point links.

40 MHz Channelling			
Channel	Frequency	Channel	Frequency
7GL1	6460.000	7GL1#	6800.000
7GL2	6500.000	7GL2#	6840.000
7GL3	6540.000	7GL3#	6880.000
7GL4	6580.000	7GL4#	6920.000
7GL5	6620.000	7GL5#	6960.000
7GL6	6660.000	7GL6#	7000.000
7GL7	6700.000	7GL7#	7040.000
7GL8	6740.000	7GL8#	7080.000

Band Plan for 7 GHz (Lower) Band 6420 - 7100 MHz

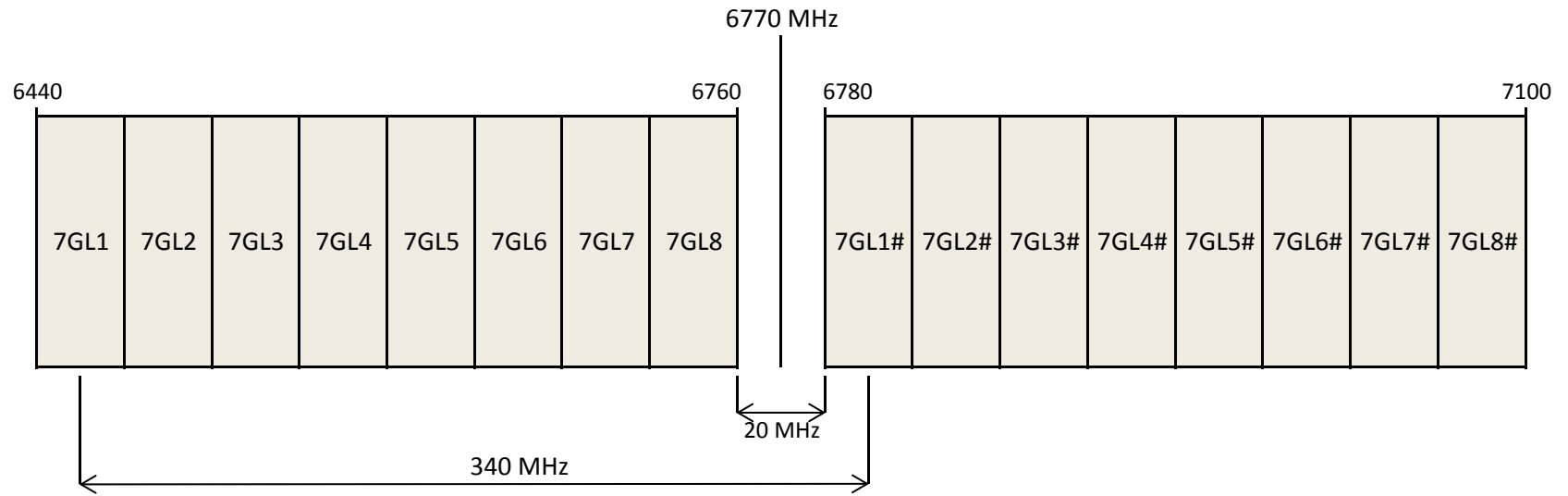

Channelling: 40 MHz

7 GHz (Middle) Band 7100 - 7425 MHz

Note: 56 MHz channels are restricted for DMR with a minimum spectral efficiency of 4 bits per second per Hertz. See Radio Licence Certification Rules (PIB 38).

56 MHz Channelling			
Channel	Frequency	Channel	Frequency
7GM45A	7236.500	7GM45A#	7397.500

28 MHz Channelling			
Channel	Frequency	Channel	Frequency
7GM3A	7194.500	7GM3A#	7355.500
7GM4A	7222.500	7GM4A#	7383.500
7GM5A	7250.500	7GM5A#	7411.500

14 MHz Channelling			
Channel	Frequency	Channel	Frequency
7GM5B	7187.500	7GM5B#	7348.500
7GM6B	7201.500	7GM6B#	7362.500
7GM7B	7215.500	7GM7B#	7376.500
7GM8B	7229.500	7GM8B#	7390.500
7GM9B	7243.500	7GM9B#	7404.500
7GM10B	7257.500	7GM10B#	7418.500

7 MHz Channelling			
Channel	Frequency	Channel	Frequency
7GM9C	7184.000	7GM9C#	7345.000
7GM10C	7191.000	7GM10C#	7352.000
7GM11C	7198.000	7GM11C#	7359.000
7GM12C	7205.000	7GM12C#	7366.000
7GM13C	7212.000	7GM13C#	7373.000
7GM14C	7219.000	7GM14C#	7380.000
7GM15C	7226.000	7GM15C#	7387.000
7GM16C	7233.000	7GM16C#	7394.000
7GM17C	7240.000	7GM17C#	7401.000
7GM18C	7247.000	7GM18C#	7408.000
7GM19C	7254.000	7GM19C#	7415.000
7GM20C	7261.000	7GM20C#	7422.000

3.5 MHz Channelling			
Channel	Frequency	Channel	Frequency
7GM17D	7182.250	7GM17D#	7343.250
7GM18D	7185.750	7GM18D#	7346.750
7GM19D	7189.250	7GM19D#	7350.250
7GM20D	7192.750	7GM20D#	7353.750
7GM21D	7196.250	7GM21D#	7357.250
7GM22D	7199.750	7GM22D#	7360.750
7GM23D	7203.250	7GM23D#	7364.250
7GM24D	7206.750	7GM24D#	7367.750
7GM25D	7210.250	7GM25D#	7371.250
7GM26D	7213.750	7GM26D#	7374.750
7GM27D	7217.250	7GM27D#	7378.250
7GM28D	7220.750	7GM28D#	7381.750
7GM29D	7224.250	7GM29D#	7385.250
7GM30D	7227.750	7GM30D#	7388.750
7GM31D	7231.250	7GM31D#	7392.250
7GM32D	7234.750	7GM32D#	7395.750
7GM33D	7238.250	7GM33D#	7399.250
7GM34D	7241.750	7GM34D#	7402.750
7GM35D	7245.250	7GM35D#	7406.250
7GM36D	7248.750	7GM36D#	7409.750
7GM37D	7252.250	7GM37D#	7413.250
7GM38D	7255.750	7GM38D#	7416.750
7GM39D	7259.250	7GM39D#	7420.250
7GM40D	7262.750	7GM40D#	7423.750

TVOB 28 MHz Channelling			
Channel	Frequency	Channel	Frequency
7GM1	7124.500	7GM1#	7285.500
7GM2	7152.500	7GM2#	7313.500
7GM1A	7138.500	7GM1A#	7299.500
7GM2A	7166.500	7GM2A#	7327.500

Note: These 28 MHz channels are restricted to user-coordinated television outside broadcast operations (TVOB).

7 GHz (Upper) Band 7425 - 7725 MHz

Note: 56 MHz channels are restricted for DMR with a minimum spectral efficiency of 4 bits per second per Hertz. See Radio Licence Certification Rules (PIB 38).

56 MHz Channelling			
Channel	Frequency	Channel	Frequency
7GU1W	7452.500	7GU1W#	7613.500
7GU2W	7508.500	7GU2W#	7669.500

28 MHz Channelling			
Channel	Frequency	Channel	Frequency
7GU1	7438.500	7GU1#	7599.500
7GU2	7466.500	7GU2#	7627.500
7GU3	7494.500	7GU3#	7655.500
7GU4	7522.500	7GU4#	7683.500
7GU5	7550.500	7GU5#	7711.500

The following 28 MHz (7GUA) channel plan is not the preferred plan and is recommended only for legacy services and equipment.

28 MHz Channelling			
Channel	Frequency	Channel	Frequency
7GU2A	7435.000	7GU2A#	7596.000
7GU6A	7463.000	7GU6A#	7624.000
7GU10A	7491.000	7GU10A#	7652.000
7GU14A	7519.000	7GU14A#	7680.000
7GU18A	7547.000	7GU18A#	7708.000

7 MHz Channelling			
Channel	Frequency	Channel	Frequency
7GU1B	7428.000	7GU1B#	7589.000
7GU2B	7435.000	7GU2B#	7596.000
7GU3B	7442.000	7GU3B#	7603.000
7GU4B	7449.000	7GU4B#	7610.000
7GU5B	7456.000	7GU5B#	7617.000
7GU6B	7463.000	7GU6B#	7624.000
7GU7B	7470.000	7GU7B#	7631.000
7GU8B	7477.000	7GU8B#	7638.000
7GU9B	7484.000	7GU9B#	7645.000
7GU10B	7491.000	7GU10B#	7652.000

7 MHz Channelling (continued)			
Channel	Frequency	Channel	Frequency
7GU11B	7498.000	7GU11B#	7659.000
7GU12B	7505.000	7GU12B#	7666.000
7GU13B	7512.000	7GU13B#	7673.000
7GU14B	7519.000	7GU14B#	7680.000
7GU15B	7526.000	7GU15B#	7687.000
7GU16B	7533.000	7GU16B#	7694.000
7GU17B	7540.000	7GU17B#	7701.000
7GU18B	7547.000	7GU18B#	7708.000
7GU19B	7554.000	7GU19B#	7715.000
7GU20B	7561.000	7GU20B#	7722.000

Band Plan for 7 GHz (Upper) Band 7425 - 7725 MHz

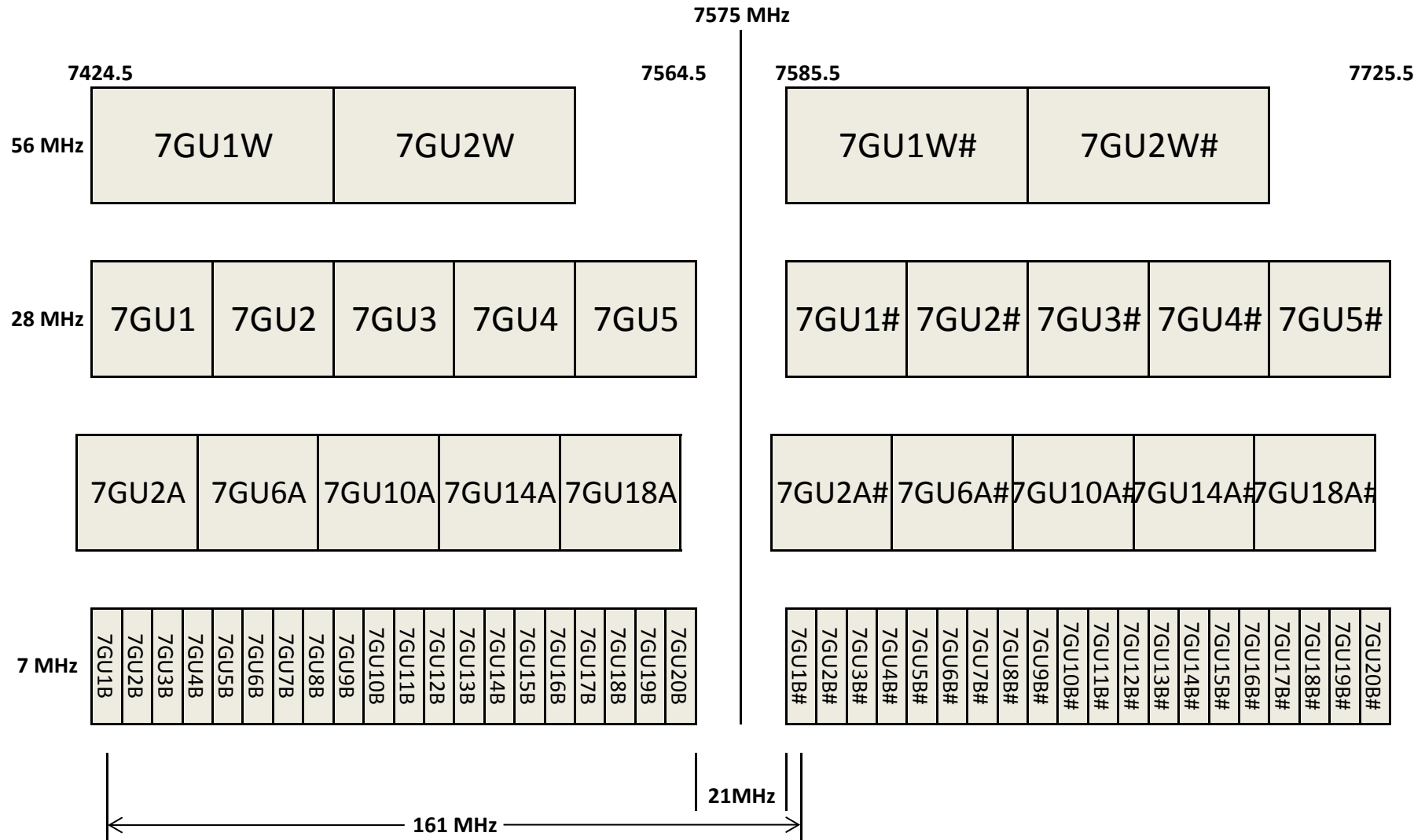

Channelling: 7, 28 and 56 MHz

8 GHz (Lower) Band 7725 - 8275 MHz

59.3 MHz Channelling

Channel	Frequency	Channel	Frequency
8GL12	7762.525	8GL12#	8073.845
8GL34	7821.825	8GL34#	8133.145
8GL56	7881.125	8GL56#	8192.445
8GL78	7940.425	8GL78#	8251.745

29.65 MHz Channelling

Channel	Frequency	Channel	Frequency
8GL1	7747.700	8GL1#	8059.020
8GL2	7777.350	8GL2#	8088.670
8GL3	7807.000	8GL3#	8118.320
8GL4	7836.650	8GL4#	8147.970
8GL5	7866.300	8GL5#	8177.620
8GL6	7895.950	8GL6#	8207.270
8GL7	7925.600	8GL7#	8236.920
8GL8	7955.250	8GL8#	8266.570

Band Plan for 8 GHz (Lower) Band 7725 - 8275 MHz

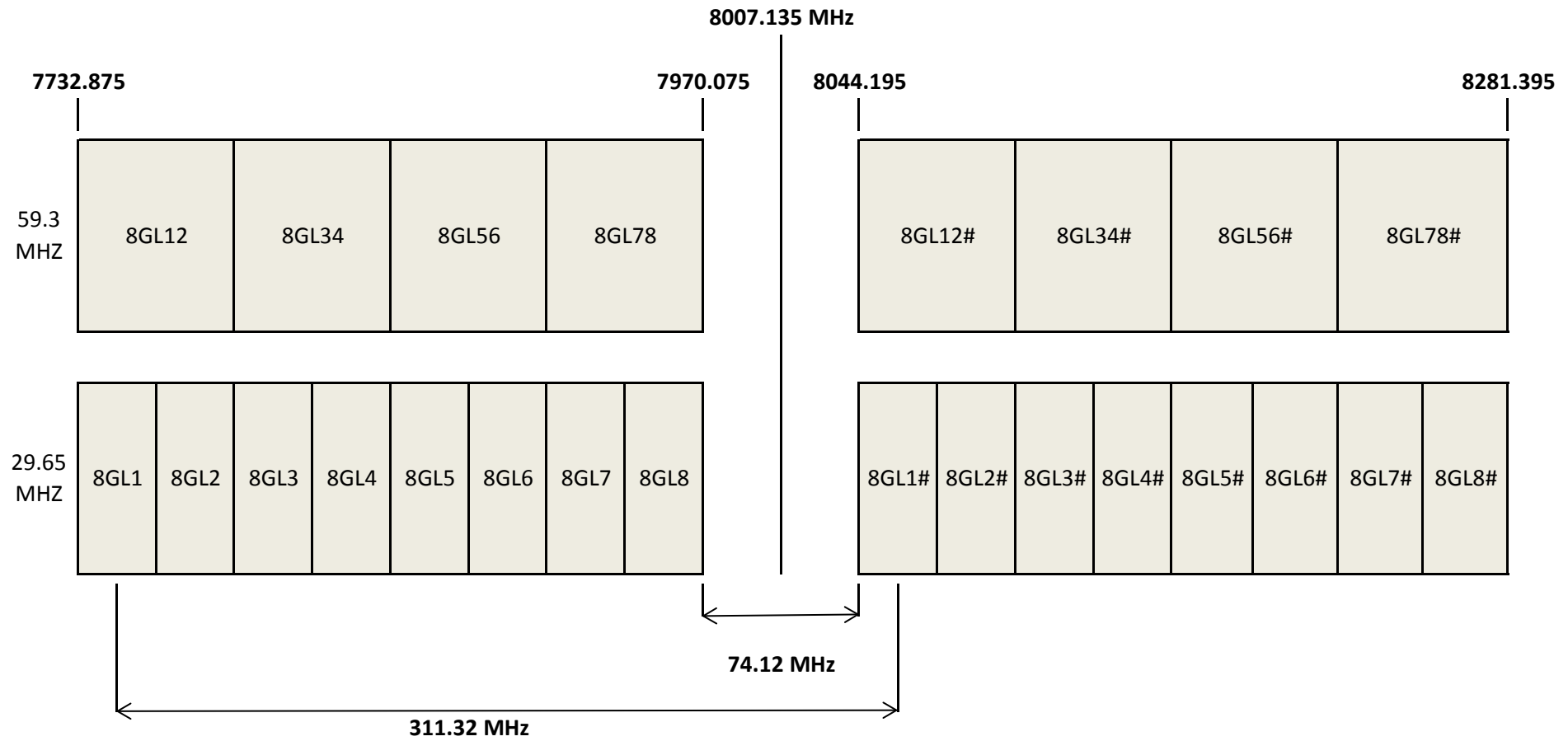

Channelling: 29.65 & 59.3 MHz

8 GHz (Upper) Band 8275 - 8500 MHz

28 MHz Channelling			
Channel	Frequency	Channel	Frequency
8GU1	8293.000	8GU1#	8412.000
8GU2	8321.000	8GU2#	8440.000
8GU3	8349.000	8GU3#	8468.000
Channel	Frequency	Channel	Frequency
8GU1A	8307.000	8GU1A#	8426.000
8GU2A	8335.000	8GU2A#	8454.000
8GU3A	8363.000	8GU3A#	8482.000

Note: The 8GU_n channels are legacy channels and unavaialbe for new services.
The two groups of channels are interleaved.

Band Plan for 8 GHz (Upper) Band 8275 - 8500 MHz

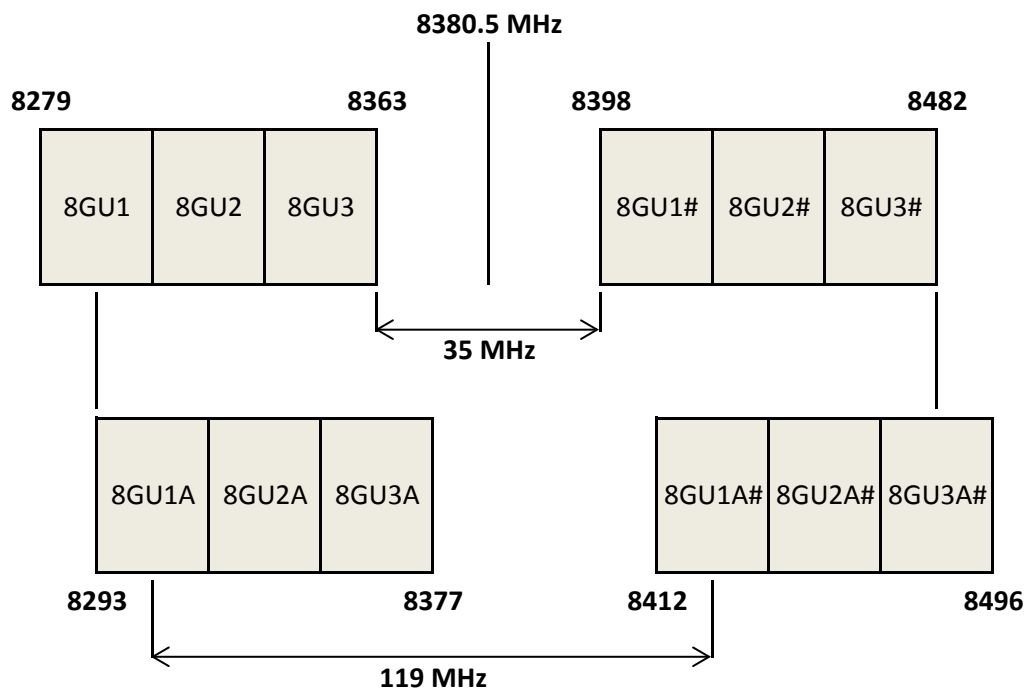

Channelling: 28 MHz

10 GHz Band 10.5 - 10.68 GHz

Note: See Radio Licence Policy Rules (PIB 58) and Radio Licence Certification Rules (PIB 38).

21 MHz Channelling			
Channel	Frequency	Channel	Frequency
10G1	10.511	10G1#	10.602
10G2	10.532	10G2#	10.623
10G3	10.553	10G3#	10.644
10G4	10.574	10G4#	10.665

7 MHz Channelling			
Channel	Frequency	Channel	Frequency
10G1A1	10.504	10G1A1#	10.595
10G1A2	10.511	10G1A2#	10.602
10G1A3	10.518	10G1A3#	10.609
10G2A1	10.525	10G2A1#	10.616
10G2A2	10.532	10G2A2#	10.623
10G2A3	10.539	10G2A3#	10.630
10G3A1	10.546	10G3A1#	10.637
10G3A2	10.553	10G3A2#	10.644
10G3A3	10.560	10G3A3#	10.651
10G4A1	10.567	10G4A1#	10.658
10G4A2	10.574	10G4A2#	10.665
10G4A3	10.581	10G4A3#	10.672

Band Plan for 10 GHz Band 10.5 - 10.68 GHz

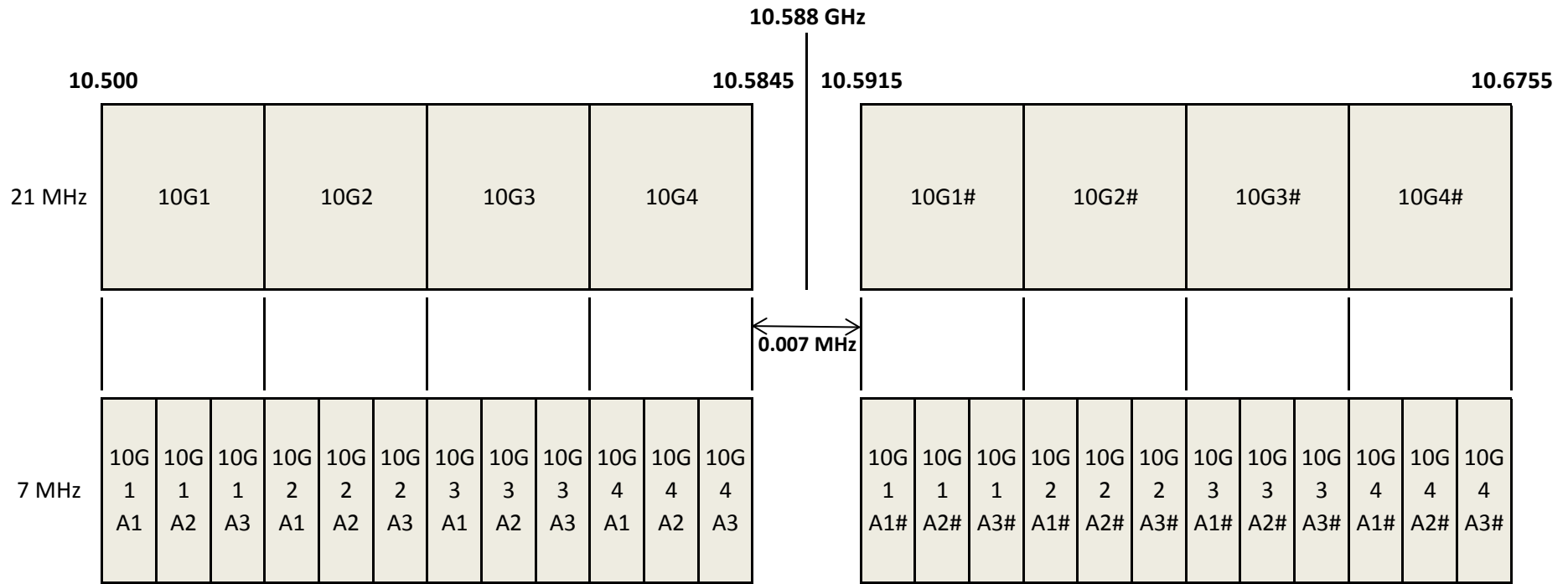

Chanelling: 7 and 21 MHz

11 GHz Band 10.7 - 11.7 GHz

Note: See Radio Licence Policy Rules (PIB 58) and Radio Licence Certification Rules (PIB 38).

80 MHz Channelling			
Channel	Frequency	Channel	Frequency
11G1W	10.755	11G1W#	11.285
11G2W	10.835	11G2W#	11.365
11G3W	10.915	11G3W#	11.445
11G4W	10.995	11G4W#	11.525
11G5W	11.075	11G5W#	11.605

40 MHz Channelling			
Channel	Frequency	Channel	Frequency
11G1	10.715	11G1#	11.245
11G2	10.755	11G2#	11.285
11G3	10.795	11G3#	11.325
11G4	10.835	11G4#	11.365
11G5	10.875	11G5#	11.405
11G6	10.915	11G6#	11.445
11G7	10.955	11G7#	11.485
11G8	10.995	11G8#	11.525
11G9	11.035	11G9#	11.565
11G10	11.075	11G10#	11.605
11G11	11.115	11G11#	11.645
11G2A	10.735	11G2A#	11.265
11G3A	10.775	11G3A#	11.305
11G4A	10.815	11G4A#	11.345
11G5A	10.855	11G5A#	11.385
11G6A	10.895	11G6A#	11.425
11G7A	10.935	11G7A#	11.465
11G8A	10.975	11G8A#	11.505
11G9A	11.015	11G9A#	11.545
11G10A	11.055	11G10A#	11.585
11G11A	11.095	11G11A#	11.625
11G12A	11.135	11G12A#	11.665

Note: The two groups of 40 MHz channels are interleaved.

Band Plan for 11 GHz Band 10.7 - 11.7 GHz

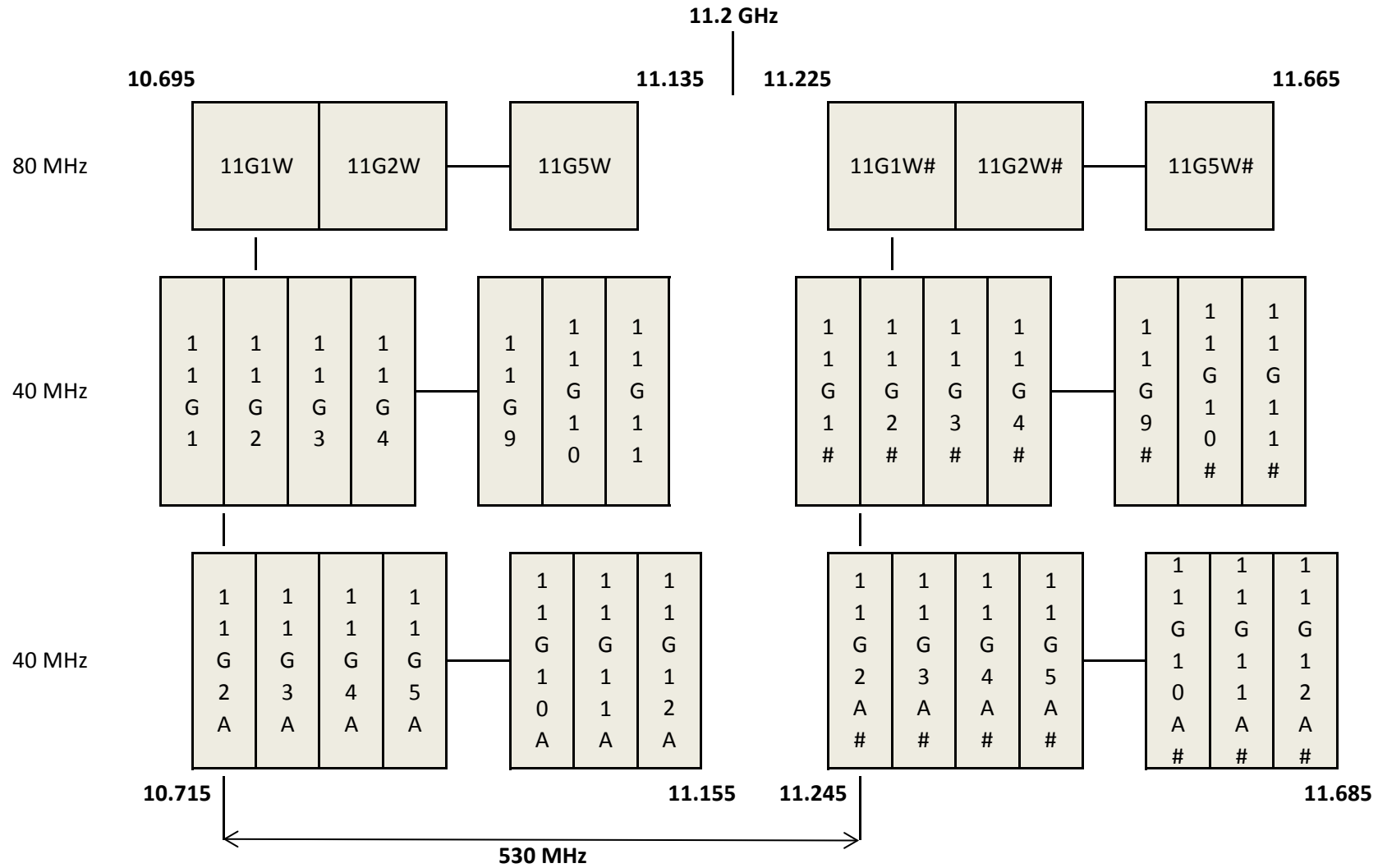

Channelling: 40 and 80 MHz

13 GHz Band 12.75 - 13.25 GHz

Note: 56 MHz channels are restricted for DMR with a minimum spectral efficiency of 4 bits per second per Hertz. See Radio Licence Certification Rules (PIB 38) for details.

56 MHz Channelling			
Channel	Frequency	Channel	Frequency
13G2W	12.835	13G2W#	13.101
13G3W	12.891	13G3W#	13.157
13G4W	12.947	13G4W#	13.213

28 MHz Channelling			
Channel	Frequency	Channel	Frequency
13G1	12.765	13G1#	13.031
13G2	12.793	13G2#	13.059
13G3	12.821	13G3#	13.087
13G4	12.849	13G4#	13.115
13G5	12.877	13G5#	13.143
13G6	12.905	13G6#	13.171
13G7	12.933	13G7#	13.199
13G8	12.961	13G8#	13.227

14 MHz Channelling			
Channel	Frequency	Channel	Frequency
13G1B	12.758	13G1B#	13.024
13G1E	12.772	13G1E#	13.038
13G2B	12.786	13G2B#	13.052
13G2E	12.800	13G2E#	13.066
13G3B	12.814	13G3B#	13.080
13G3E	12.828	13G3E#	13.094
13G4B	12.842	13G4B#	13.108
13G4E	12.856	13G4E#	13.122
13G5B	12.870	13G5B#	13.136
13G5E	12.884	13G5E#	13.150
13G6B	12.898	13G6B#	13.164
13G6E	12.912	13G6E#	13.178
13G7B	12.926	13G7B#	13.192
13G7E	12.940	13G7E#	13.206
13G8B	12.954	13G8B#	13.220
13G8E	12.968	13G8E#	13.234

7 MHz Channelling			
Channel	Frequency	Channel	Frequency
13G1A	12.7545	13G1A#	13.0205
13G1C	12.7615	13G1C#	13.0275
13G1D	12.7685	13G1D#	13.0345
13G1F	12.7755	13G1F#	13.0415
13G2A	12.7825	13G2A#	13.0485
13G2C	12.7895	13G2C#	13.0555
13G2D	12.7965	13G2D#	13.0625
13G2F	12.8035	13G2F#	13.0695
13G3A	12.8105	13G3A#	13.0765
13G3C	12.8175	13G3C#	13.0835
13G3D	12.8245	13G3D#	13.0905
13G3F	12.8315	13G3F#	13.0975
13G4A	12.8385	13G4A#	13.1045
13G4C	12.8455	13G4C#	13.1115
13G4D	12.8525	13G4D#	13.1185
13G4F	12.8595	13G4F#	13.1255
13G5A	12.8665	13G5A#	13.1325
13G5C	12.8735	13G5C#	13.1395
13G5D	12.8805	13G5D#	13.1465
13G5F	12.8875	13G5F#	13.1535
13G6A	12.8945	13G6A#	13.1605
13G6C	12.9015	13G6C#	13.1675
13G6D	12.9085	13G6D#	13.1745
13G6F	12.9155	13G6F#	13.1815
13G7A	12.9225	13G7A#	13.1885
13G7C	12.9295	13G7C#	13.1955
13G7D	12.9365	13G7D#	13.2025
13G7F	12.9435	13G7F#	13.2095
13G8A	12.9505	13G8A#	13.2165
13G8C	12.9575	13G8C#	13.2235
13G8D	12.9645	13G8D#	13.2305
13G8F	12.9715	13G8F#	13.2375

Band Plan for 13 GHz Band 12.75 - 13.25 GHz

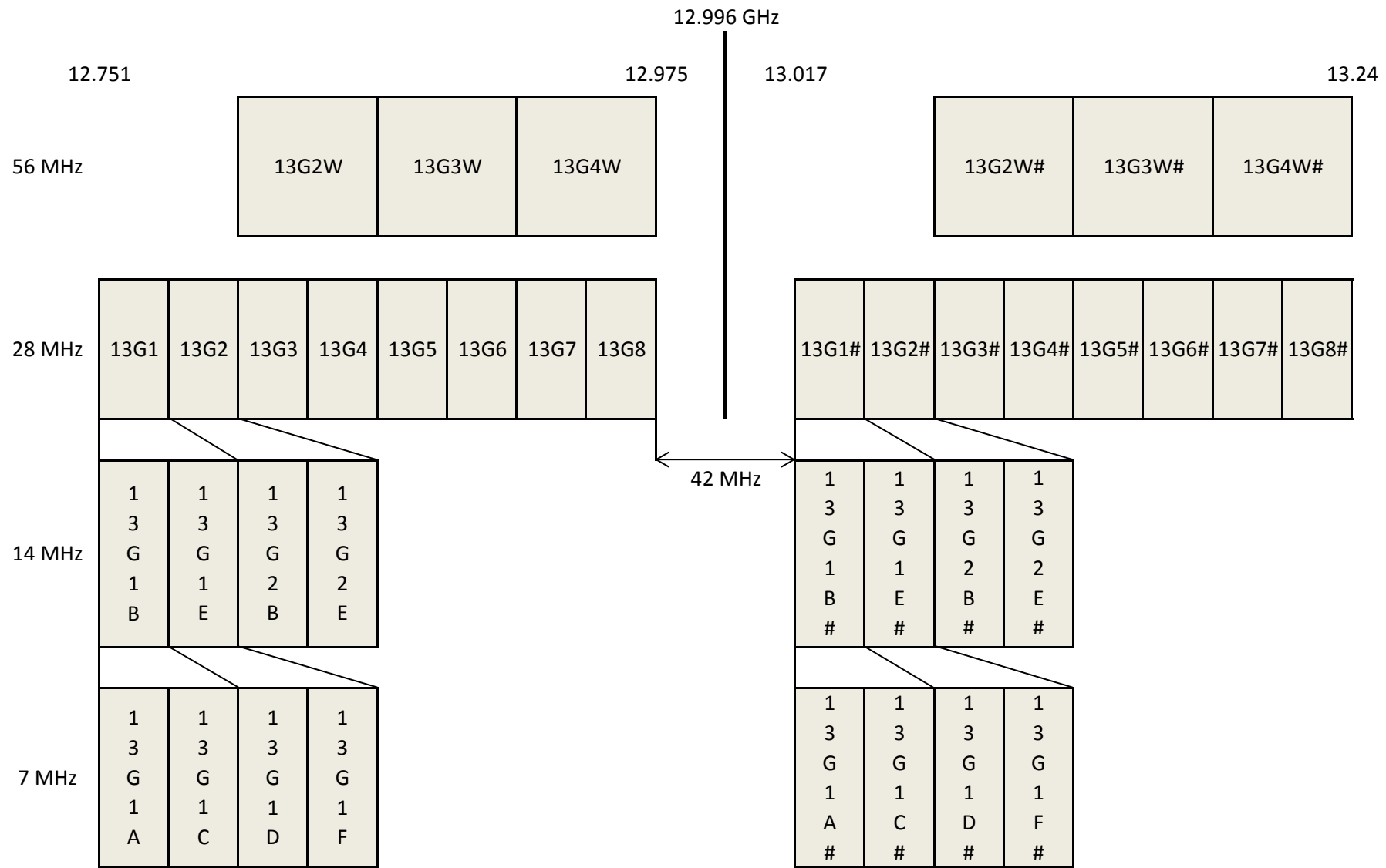

Channelling: 7, 14, 28 and 56 MHz

15 GHz Band 14.5 - 15.35 GHz

Note: See Radio Licence Policy Rules (PIB 58) and Radio Licence Certification Rules (PIB 38).

28 MHz Channelling			
Channel	Frequency	Channel	Frequency
15G1	14.515	15G1#	15.159
15G2	14.543	15G2#	15.187
15G3	14.571	15G3#	15.215
15G4	14.599	15G4#	15.243
15G5	14.627	15G5#	15.271
15G6	14.655	15G6#	15.299
15G7	14.683	15G7#	15.327

14 MHz Channelling			
Channel	Frequency	Channel	Frequency
15G2A1	14.536	15G2A1#	15.180
15G2A2	14.550	15G2A2#	15.194
15G3A1	14.564	15G3A1#	15.208
15G3A2	14.578	15G3A2#	15.222
15G4A1	14.592	15G4A1#	15.236
15G4A2	14.606	15G4A2#	15.250

7 MHz Channelling			
Channel	Frequency	Channel	Frequency
15G1B1	14.5045	15G1B1#	15.1485
15G1B2	14.5115	15G1B2#	15.1555
15G1B3	14.5185	15G1B3#	15.1625
15G1B4	14.5255	15G1B4#	15.1695
15G2B1	14.5325	15G2B1#	15.1765
15G2B2	14.5395	15G2B2#	15.1835
15G2B3	14.5465	15G2B3#	15.1905
15G2B4	14.5535	15G2B4#	15.1975
15G3B1	14.5605	15G3B1#	15.2045
15G3B2	14.5675	15G3B2#	15.2115
15G3B3	14.5745	15G3B3#	15.2185
15G3B4	14.5815	15G3B4#	15.2255
15G4B1	14.5885	15G4B1#	15.2325
15G4B2	14.5955	15G4B2#	15.2395
15G4B3	14.6025	15G4B3#	15.2465
15G4B4	14.6095	15G4B4#	15.2535

3.5 MHz Channelling			
Channel	Frequency	Channel	Frequency
15G1C1	14.50275	15G1C1#	15.14675
15G1C2	14.50625	15G1C2#	15.15025
15G1C3	14.50975	15G1C3#	15.15375
15G1C4	14.51325	15G1C4#	15.15725
15G1C5	14.51675	15G1C5#	15.16075
15G1C6	14.52025	15G1C6#	15.16425
15G1C7	14.52375	15G1C7#	15.16775
15G1C8	14.52725	15G1C8#	15.17125

Band Plan for 15 GHz Band 14.5 - 15.35 GHz

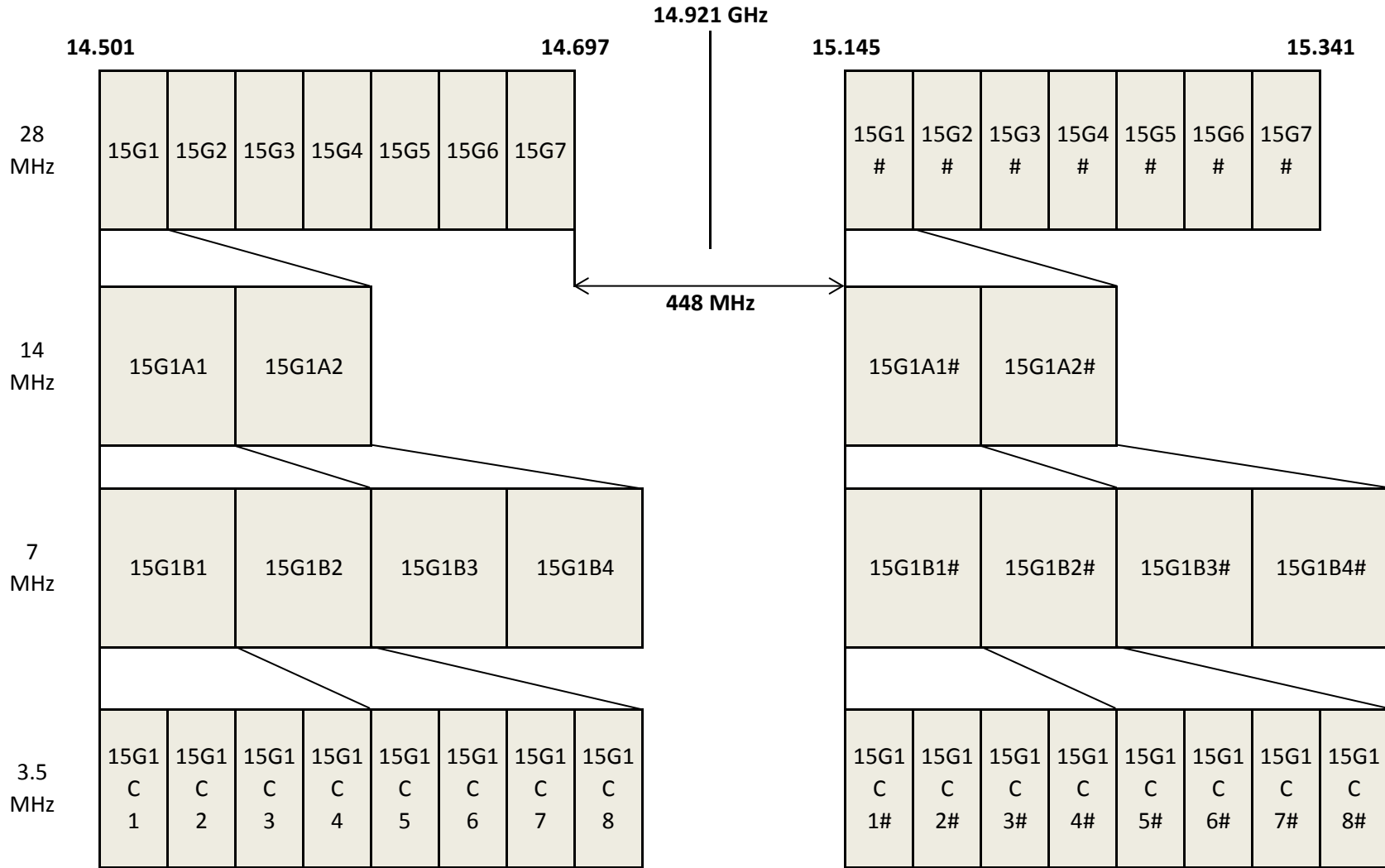

Channelling: 3.5, 7, 14 and 28 MHz

18 GHz Band 17.7 - 19.7 GHz

Note: See Radio Licence Policy Rules (PIB 58) and Radio Licence Certification Rules (PIB 38).

110 MHz Channelling			
Channel	Frequency	Channel	Frequency
18G1A	17.810	18G1A#	18.820
18G2A	17.920	18G2A#	18.930
18G3A	18.030	18G3A#	19.040
18G4A	18.140	18G4A#	19.150
18G5A	18.250	18G5A#	19.260
18G6A	18.360	18G6A#	19.370
18G7A	18.470	18G7A#	19.480
18G8A	18.580	18G8A#	19.590

55 MHz Channelling			
Channel	Frequency	Channel	Frequency
18G1B1	17.755	18G1B1#	18.765
18G1B2	17.810	18G1B2#	18.820
18G2B1	17.865	18G2B1#	18.875
18G2B2	17.920	18G2B2#	18.930
18G3B1	17.975	18G3B1#	18.985
18G3B2	18.030	18G3B2#	19.040
18G4B1	18.085	18G4B1#	19.095
18G4B2	18.140	18G4B2#	19.150
18G5B1	18.195	18G5B1#	19.205
18G5B2	18.250	18G5B2#	19.260
18G6B1	18.305	18G6B1#	19.315
18G6B2	18.360	18G6B2#	19.370
18G7B1	18.415	18G7B1#	19.425
18G7B2	18.470	18G7B2#	19.480
18G8B1	18.525	18G8B1#	19.535
18G8B2	18.580	18G8B2#	19.590

27.5 MHz Channelling			
Channel	Frequency	Channel	Frequency
18G1C1	17.7275	18G1C1#	18.7375
18G1C2	17.7550	18G1C2#	18.7650
18G1C3	17.7825	18G1C3#	18.7925
18G1C4	17.8100	18G1C4#	18.8200
18G2C1	17.8375	18G2C1#	18.8475
18G2C2	17.8650	18G2C2#	18.8750
18G2C3	17.8925	18G2C3#	18.9025

27.5 MHz Channelling (continued)

Channel	Frequency	Channel	Frequency
18G2C4	17.9200	18G2C4#	18.9300
18G3C1	17.9475	18G3C1#	18.9575
18G3C2	17.9750	18G3C2#	18.9850
18G3C3	18.0025	18G3C3#	19.0125
18G3C4	18.0300	18G3C4#	19.0400
18G4C1	18.0575	18G4C1#	19.0675
18G4C2	18.0850	18G4C2#	19.0950
18G4C3	18.1125	18G4C3#	19.1225
18G4C4	18.1400	18G4C4#	19.1500
18G5C1	18.1675	18G5C1#	19.1775
18G5C2	18.1950	18G5C2#	19.2050
18G5C3	18.2225	18G5C3#	19.2325
18G5C4	18.2500	18G5C4#	19.2600
18G6C1	18.2775	18G6C1#	19.2875
18G6C2	18.3050	18G6C2#	19.3150
18G6C3	18.3325	18G6C3#	19.3425
18G6C4	18.3600	18G6C4#	19.3700
18G7C1	18.3875	18G7C1#	19.3975
18G7C2	18.4150	18G7C2#	19.4250
18G7C3	18.4425	18G7C3#	19.4525
18G7C4	18.4700	18G7C4#	19.4800
18G8C1	18.4975	18G8C1#	19.5075
18G8C2	18.5250	18G8C2#	19.5350
18G8C3	18.5525	18G8C3#	19.5625
18G8C4	18.5800	18G8C4#	19.5900

7 MHz Channelling

Channel	Frequency	Channel	Frequency
18G6D4	18.2980	18G6D4#	19.3080
18G6D5	18.3050	18G6D5#	19.3150
18G6D6	18.3120	18G6D6#	19.3220
18G6D7	18.3255	18G6D7#	19.3355
18G6D8	18.3325	18G6D8#	19.3425
18G6D9	18.3395	18G6D9#	19.3495
18G6D10	18.3530	18G6D10#	19.3630
18G6D11	18.3600	18G6D11#	19.3700
18G6D12	18.3670	18G6D12#	19.3770

Band Plan for 18 GHz Band 17.7 - 19.7 GHz

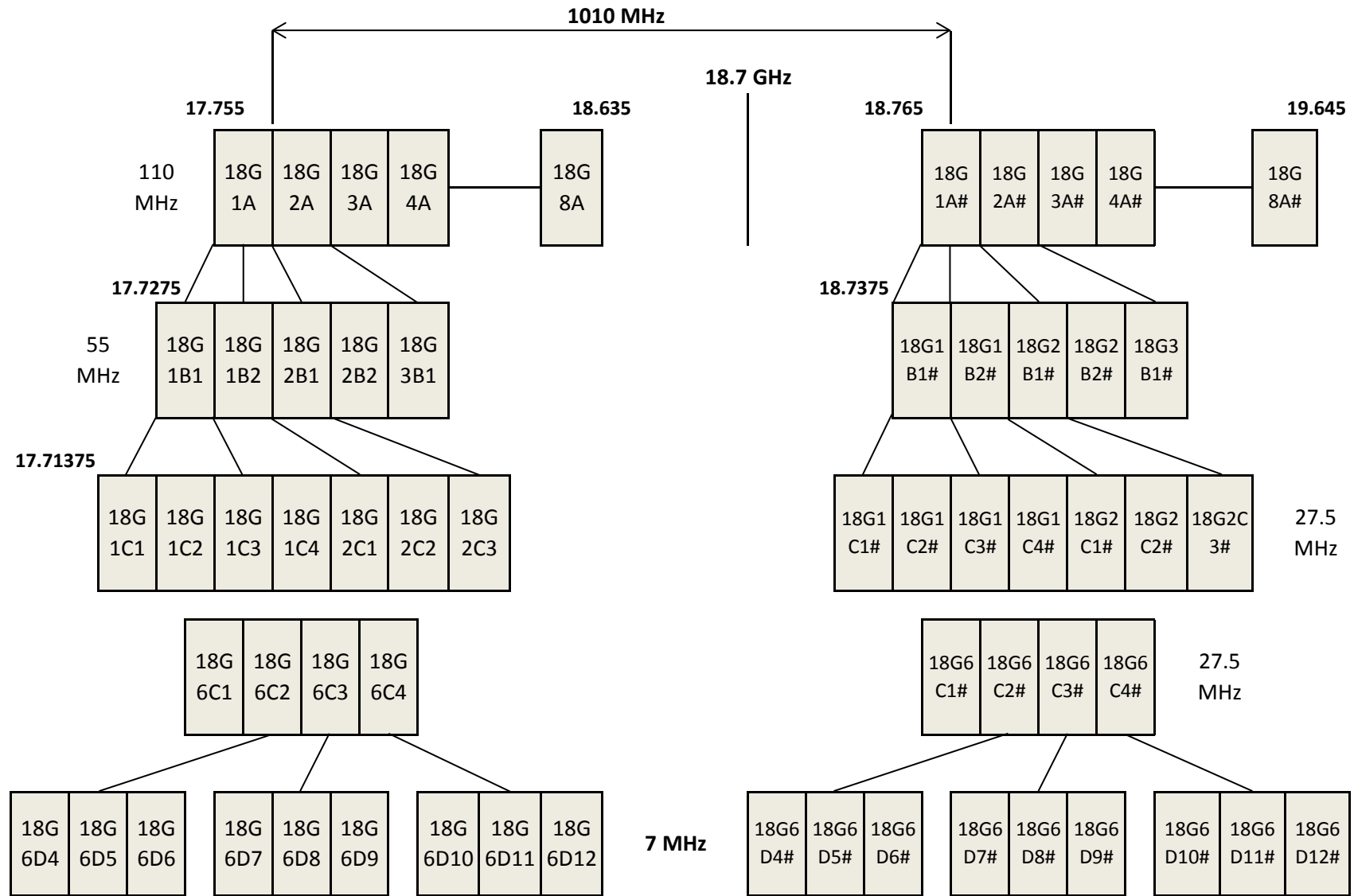

Channelling: 7, 27.5, 55 and 110 MHz

23 GHz Band 21.2 - 23.6 GHz

112 MHz Channelling			
Channel	Frequency	Channel	Frequency
23G1	21.280	23G1#	22.512
23G2	21.392	23G2#	22.624
23G3	21.504	23G3#	22.736
23G4	21.616	23G4#	22.848
23G5	21.728	23G5#	22.960
23G6	21.840	23G6#	23.072
23G7	21.952	23G7#	23.184
23G8	22.064	23G8#	23.296
23G9	22.176	23G9#	23.408
23G10	22.288	23G10#	23.520

56 MHz Channelling			
Channel	Frequency	Channel	Frequency
23G1A1	21.252	23G1A1#	22.484
23G1A2	21.308	23G1A2#	22.540
23G2A1	21.364	23G2A1#	22.596
23G2A2	21.420	23G2A2#	22.652
23G3A1	21.476	23G3A1#	22.708
23G3A2	21.532	23G3A2#	22.764
23G4A1	21.588	23G4A1#	22.820
23G4A2	21.644	23G4A2#	22.876
23G5A1	21.700	23G5A1#	22.932
23G5A2	21.756	23G5A2#	22.988
23G6A1	21.812	23G6A1#	23.044
23G6A2	21.868	23G6A2#	23.100
23G7A1	21.924	23G7A1#	23.156
23G7A2	21.980	23G7A2#	23.212
23G8A1	22.036	23G8A1#	23.268
23G8A2	22.092	23G8A2#	23.324
23G9A1	22.148	23G9A1#	23.380
23G9A2	22.204	23G9A2#	23.436
23G10A1	22.260	23G10A1#	23.492

Special channels for forward video/reverse camera control.

Note: The forward channel is 56 MHz wide, the reverse channel is 500 kHz wide

Channel	Forward Frequency	Reverse Frequency
23G10A2	22.316	22.361
23G10A2#	23.548	23.593

28 MHz Channelling			
Channel	Frequency	Channel	Frequency
23G1B1	21.238	23G1B1#	22.470
23G1B2	21.266	23G1B2#	22.498
23G1B3	21.294	23G1B3#	22.526
23G1B4	21.322	23G1B4#	22.554
23G2B1	21.350	23G2B1#	22.582
23G2B2	21.378	23G2B2#	22.610
23G2B3	21.406	23G2B3#	22.638
23G2B4	21.434	23G2B4#	22.666
23G3B1	21.462	23G3B1#	22.694
23G3B2	21.490	23G3B2#	22.722
23G3B3	21.518	23G3B3#	22.750
23G3B4	21.546	23G3B4#	22.778
23G4B1	21.574	23G4B1#	22.806
23G4B2	21.602	23G4B2#	22.834
23G4B3	21.630	23G4B3#	22.862
23G4B4	21.658	23G4B4#	22.890
23G5B1	21.686	23G5B1#	22.918
23G5B2	21.714	23G5B2#	22.946
23G5B3	21.742	23G5B3#	22.974
23G5B4	21.770	23G5B4#	23.002
23G6B1	21.798	23G6B1#	23.030
23G6B2	21.826	23G6B2#	23.058
23G6B3	21.854	23G6B3#	23.086
23G6B4	21.882	23G6B4#	23.114
23G7B1	21.910	23G7B1#	23.142
23G7B2	21.938	23G7B2#	23.170
23G7B3	21.966	23G7B3#	23.198
23G7B4	21.994	23G7B4#	23.226
23G8B1	22.022	23G8B1#	23.254
23G8B2	22.050	23G8B2#	23.282
23G8B3	22.078	23G8B3#	23.310
23G8B4	22.106	23G8B4#	23.338
23G9B1	22.134	23G9B1#	23.366
23G9B2	22.162	23G9B2#	23.394
23G9B3	22.190	23G9B3#	23.422
23G9B4	22.218	23G9B4#	23.450
23G10B1	22.246	23G10B1#	23.478
23G10B2	22.274	23G10B2#	23.506

14 MHz Channelling			
Channel	Frequency	Channel	Frequency
23G1C1	21.231	23G1C1#	22.463
23G1C2	21.245	23G1C2#	22.477
23G1C3	21.259	23G1C3#	22.491
23G1C4	21.273	23G1C4#	22.505
23G1C5	21.287	23G1C5#	22.519
23G1C6	21.301	23G1C6#	22.533
23G1C7	21.315	23G1C7#	22.547
23G1C8	21.329	23G1C8#	22.561
23G7C1	21.903	23G7C1#	23.135
23G7C2	21.917	23G7C2#	23.149
23G7C3	21.931	23G7C3#	23.163
23G7C4	21.945	23G7C4#	23.177
23G7C5	21.959	23G7C5#	23.191
23G7C6	21.973	23G7C6#	23.205
23G7C7	21.987	23G7C7#	23.219
23G7C8	22.001	23G7C8#	23.233
23G8C1	22.015	23G8C1#	23.247
23G8C2	22.029	23G8C2#	23.261
23G8C3	22.043	23G8C3#	23.275
23G8C4	22.057	23G8C4#	23.289
23G8C5	22.071	23G8C5#	23.303
23G8C6	22.085	23G8C6#	23.317
23G8C7	22.099	23G8C7#	23.331
23G8C8	22.113	23G8C8#	23.345
23G9C1	22.127	23G9C1#	23.359
23G9C2	22.141	23G9C2#	23.373
23G9C3	22.155	23G9C3#	23.387
23G9C4	22.169	23G9C4#	23.401
23G9C5	22.183	23G9C5#	23.415
23G9C6	22.197	23G9C6#	23.429
23G9C7	22.211	23G9C7#	23.443
23G9C8	22.225	23G9C8#	23.457

7 MHz Channelling			
Channel	Frequency	Channel	Frequency
23G1D1	21.2275	23G1D1#	22.4595
23G1D2	21.2345	23G1D2#	22.4665
23G1D3	21.2415	23G1D3#	22.4735
23G1D4	21.2485	23G1D4#	22.4805
23G1D5	21.2555	23G1D5#	22.4875
23G1D6	21.2625	23G1D6#	22.4945
23G1D7	21.2695	23G1D7#	22.5015
23G1D8	21.2765	23G1D8#	22.5085
23G1D9	21.2835	23G1D9#	22.5155
23G1D10	21.2905	23G1D10#	22.5225
23G1D11	21.2975	23G1D11#	22.5295
23G1D12	21.3045	23G1D12#	22.5365
23G1D13	21.3115	23G1D13#	22.5435
23G1D14	21.3185	23G1D14#	22.5505
23G1D15	21.3255	23G1D15#	22.5575
23G1D16	21.3325	23G1D16#	22.5645
23G7D1	21.8995	23G7D1#	23.1315
23G7D2	21.9065	23G7D2#	23.1385
23G7D3	21.9135	23G7D3#	23.1455
23G7D4	21.9205	23G7D4#	23.1525
23G7D5	21.9275	23G7D5#	23.1595
23G7D6	21.9345	23G7D6#	23.1665
23G7D7	21.9415	23G7D7#	23.1735
23G7D8	21.9485	23G7D8#	23.1805
23G7D9	21.9555	23G7D9#	23.1875
23G7D10	21.9625	23G7D10#	23.1945
23G7D11	21.9695	23G7D11#	23.2015
23G7D12	21.9765	23G7D12#	23.2085
23G7D13	21.9835	23G7D13#	23.2155
23G7D14	21.9905	23G7D14#	23.2225
23G7D15	21.9975	23G7D15#	23.2295
23G7D16	22.0045	23G7D16#	23.2365
23G8D1	22.0115	23G8D1#	23.2435
23G8D2	22.0185	23G8D2#	23.2505
23G8D3	22.0255	23G8D3#	23.2575
23G8D4	22.0325	23G8D4#	23.2645
23G8D5	22.0395	23G8D5#	23.2715
23G8D6	22.0465	23G8D6#	23.2785
23G8D7	22.0535	23G8D7#	23.2855
23G8D8	22.0605	23G8D8#	23.2925
23G8D9	22.0675	23G8D9#	23.2995
23G8D10	22.0745	23G8D10#	23.3065
23G8D11	22.0815	23G8D11#	23.3135
23G8D12	22.0885	23G8D12#	23.3205
23G8D13	22.0955	23G8D13#	23.3275

7 MHz Channelling (continued)			
Channel	Frequency	Channel	Frequency
23G8D14	22.1025	23G8D14#	23.3345
23G8D15	22.1095	23G8D15#	23.3415
23G8D16	22.1165	23G8D16#	23.3485
23G9D1	22.1235	23G9D1#	23.3555
23G9D2	22.1305	23G9D2#	23.3625
23G9D3	22.1375	23G9D3#	23.3695
23G9D4	22.1445	23G9D4#	23.3765
23G9D5	22.1515	23G9D5#	23.3835
23G9D6	22.1585	23G9D6#	23.3905
23G9D7	22.1655	23G9D7#	23.3975
23G9D8	22.1725	23G9D8#	23.4045
23G9D9	22.1795	23G9D9#	23.4115
23G9D10	22.1865	23G9D10#	23.4185
23G9D11	22.1935	23G9D11#	23.4255
23G9D12	22.2005	23G9D12#	23.4325
23G9D13	22.2075	23G9D13#	23.4395
23G9D14	22.2145	23G9D14#	23.4465
23G9D15	22.2215	23G9D15#	23.4535
23G9D16	22.2285	23G9D16#	23.4605

Band Plan for 23 GHz Band 21.2 - 23.6 GHz

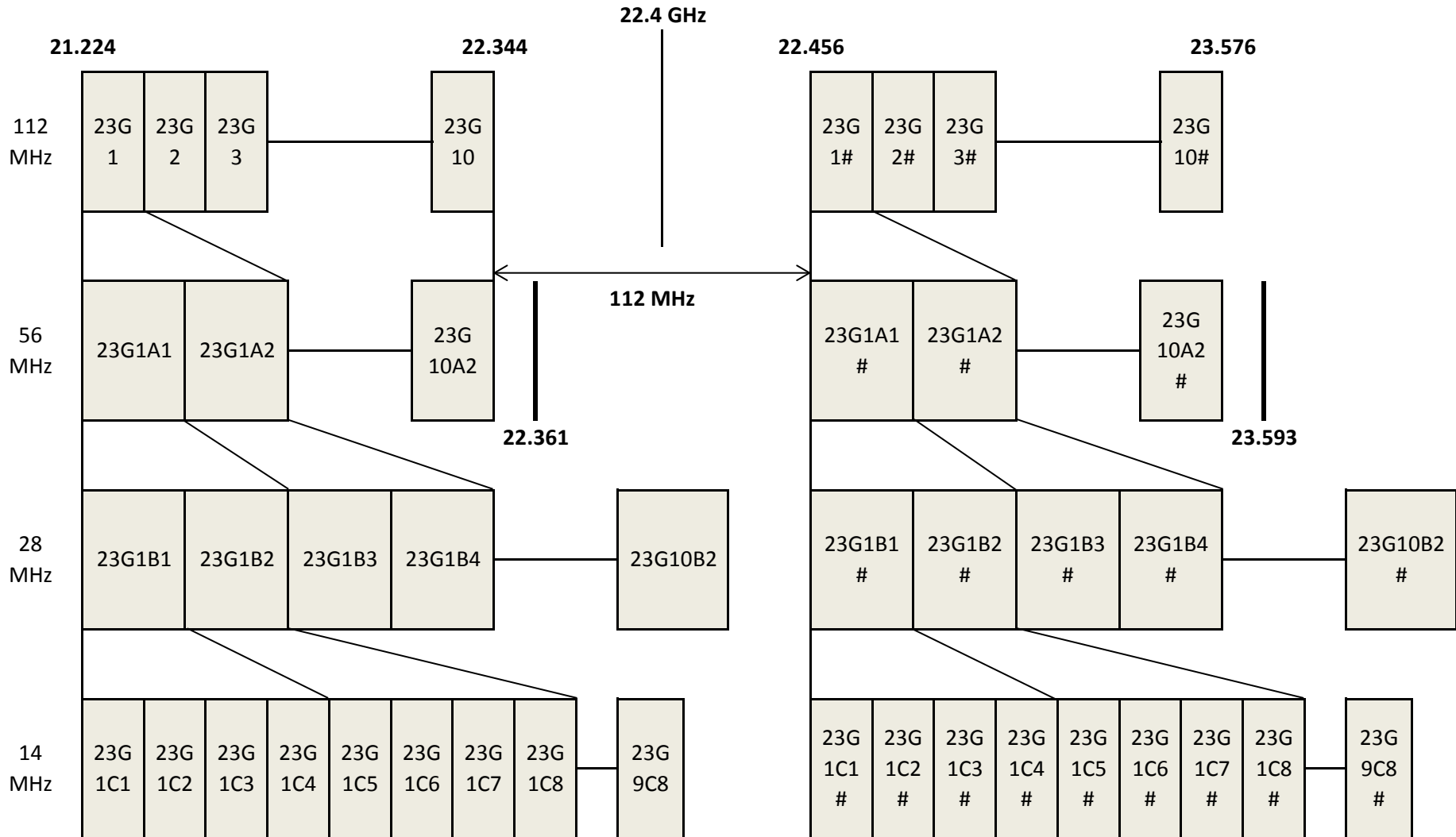

Channelling: 7, 14, 28, 56 and 112 MHz

38 GHz Band 37.0 - 40.0 GHz

Note: 56 MHz channels are restricted for DMR with a minimum spectral efficiency of 4 bits per second per Hertz. See Radio Licence Certification Rules (PIB 38) for details.

56 MHz Channelling			
Channel	Frequency	Channel	Frequency
38G1W	37.086	38G1W#	38.346
38G2W	37.142	38G2W#	38.402
38G3W	37.198	38G3W#	38.458
38G4W	37.254	38G4W#	38.514
38G5W	37.310	38G5W#	38.570
38G6W	37.366	38G6W#	38.626
38G7W	37.422	38G7W#	38.682
38G8W	37.478	38G8W#	38.738
38G9W	37.534	38G9W#	38.794
38G10W	37.590	38G10W#	38.850
38G11W	37.646	38G11W#	38.906
38G12W	37.702	38G12W#	38.962
38G13W	37.758	38G13W#	39.018
38G14W	37.814	38G14W#	39.074
38G15W	37.870	38G15W#	39.130
38G16W	37.926	38G16W#	39.186
38G17W	37.982	38G17W#	39.242
38G18W	38.038	38G18W#	39.298
38G19W	38.094	38G19W#	39.354
38G20W	38.150	38G20W#	39.410

28 MHz Channelling			
Channel	Frequency	Channel	Frequency
38G1	37.072	38G1#	38.332
38G2	37.100	38G2#	38.360
38G3	37.128	38G3#	38.388
38G4	37.156	38G4#	38.416
38G5	37.184	38G5#	38.444
38G6	37.212	38G6#	38.472
38G7	37.240	38G7#	38.500
38G8	37.268	38G8#	38.528
38G9	37.296	38G9#	38.556
38G10	37.324	38G10#	38.584
38G11	37.352	38G11#	38.612
38G12	37.380	38G12#	38.640
38G13	37.408	38G13#	38.668
38G14	37.436	38G14#	38.696
38G15	37.464	38G15#	38.724
38G16	37.492	38G16#	38.752

28 MHz Channelling (continued)			
Channel	Frequency	Channel	Frequency
38G17	37.520	38G17#	38.780
38G18	37.548	38G18#	38.808
38G19	37.576	38G19#	38.836
38G20	37.604	38G20#	38.864
38G21	37.632	38G21#	38.892
38G22	37.660	38G22#	38.920
38G23	37.688	38G23#	38.948
38G24	37.716	38G24#	38.976
38G25	37.744	38G25#	39.004
38G26	37.772	38G26#	39.032
38G27	37.800	38G27#	39.060
38G28	37.828	38G28#	39.088
38G29	37.856	38G29#	39.116
38G30	37.884	38G30#	39.144
38G31	37.912	38G31#	39.172
38G32	37.940	38G32#	39.200
38G33	37.968	38G33#	39.228
38G34	37.996	38G34#	39.256
38G35	38.024	38G35#	39.284
38G36	38.052	38G36#	39.312
38G37	38.080	38G37#	39.340
38G38	38.108	38G38#	39.368
38G39	38.136	38G39#	39.396
38G40	38.164	38G40#	39.424

14 MHz Channelling			
Block A			
Channel	Frequency	Channel	Frequency
38G1A	37.065	38G1A#	38.325
38G2A	37.079	38G2A#	38.339
38G3A	37.093	38G3A#	38.353
38G4A	37.107	38G4A#	38.367
38G5A	37.121	38G5A#	38.381
38G6A	37.135	38G6A#	38.395
38G7A	37.149	38G7A#	38.409
38G8A	37.163	38G8A#	38.423
38G9A	37.177	38G9A#	38.437
38G10A	37.191	38G10A#	38.451
38G11A	37.205	38G11A#	38.465
38G12A	37.219	38G12A#	38.479
38G13A	37.233	38G13A#	38.493
38G14A	37.247	38G14A#	38.507
38G15A	37.261	38G15A#	38.521
38G16A	37.275	38G16A#	38.535
38G17A	37.289	38G17A#	38.549

14 MHz Channelling			
Block A (continued)			
Channel	Frequency	Channel	Frequency
38G18A	37.303	38G18A#	38.563
38G19A	37.317	38G19A#	38.577
38G20A	37.331	38G20A#	38.591
Block B			
Channel	Frequency	Channel	Frequency
38G21A	37.345	38G21A#	38.605
38G22A	37.359	38G22A#	38.619
38G23A	37.373	38G23A#	38.633
38G24A	37.387	38G24A#	38.647
38G25A	37.401	38G25A#	38.661
38G26A	37.415	38G26A#	38.675
38G27A	37.429	38G27A#	38.689
38G28A	37.443	38G28A#	38.703
38G29A	37.457	38G29A#	38.717
38G30A	37.471	38G30A#	38.731
38G31A	37.485	38G31A#	38.745
38G32A	37.499	38G32A#	38.759
38G33A	37.513	38G33A#	38.773
38G34A	37.527	38G34A#	38.787
38G35A	37.541	38G35A#	38.801
38G36A	37.555	38G36A#	38.815
38G37A	37.569	38G37A#	38.829
38G38A	37.583	38G38A#	38.843
38G39A	37.597	38G39A#	38.857
38G40A	37.611	38G40A#	38.871
Block C			
Channel	Frequency	Channel	Frequency
38G41A	37.625	38G41A#	38.885
38G42A	37.639	38G42A#	38.899
38G43A	37.653	38G43A#	38.913
38G44A	37.667	38G44A#	38.927
38G45A	37.681	38G45A#	38.941
38G46A	37.695	38G46A#	38.955
38G47A	37.709	38G47A#	38.969
38G48A	37.723	38G48A#	38.983
38G49A	37.737	38G49A#	38.997
38G50A	37.751	38G50A#	39.011
38G51A	37.765	38G51A#	39.025
38G52A	37.779	38G52A#	39.039
38G53A	37.793	38G53A#	39.053
38G54A	37.807	38G54A#	39.067
38G55A	37.821	38G55A#	39.081
38G56A	37.835	38G56A#	39.095
38G57A	37.849	38G57A#	39.109

14 MHz Channelling			
Block C (continued)			
Channel	Frequency	Channel	Frequency
38G58A	37.863	38G58A#	39.123
38G59A	37.877	38G59A#	39.137
38G60A	37.891	38G60A#	39.151
Block D			
Channel	Frequency	Channel	Frequency
38G61A	37.905	38G61A#	39.165
38G62A	37.919	38G62A#	39.179
38G63A	37.933	38G63A#	39.193
38G64A	37.947	38G64A#	39.207
38G65A	37.961	38G65A#	39.221
38G66A	37.975	38G66A#	39.235
38G67A	37.989	38G67A#	39.249
38G68A	38.003	38G68A#	39.263
38G69A	38.017	38G69A#	39.277
38G70A	38.031	38G70A#	39.291
38G71A	38.045	38G71A#	39.305
38G72A	38.059	38G72A#	39.319
38G73A	38.073	38G73A#	39.333
38G74A	38.087	38G74A#	39.347
38G75A	38.101	38G75A#	39.361
38G76A	38.115	38G76A#	39.375
38G77A	38.129	38G77A#	39.389
38G78A	38.143	38G78A#	39.403
38G79A	38.157	38G79A#	39.417
38G80A	38.171	38G80A#	39.431

7 MHz Channelling			
Channel	Frequency	Channel	Frequency
38G39B	37.3275	38G39B#	38.5875
38G40B	37.3345	38G40B#	38.5945
38G79B	37.6075	38G79B#	38.8675
38G80B	37.6145	38G80B#	38.8745
38G119B	37.8875	38G119B#	39.1475
38G120B	37.8945	38G120B#	39.1545
38G159B	38.1675	38G159B#	39.4275
38G160B	38.1745	38G160B#	39.4345

3.5 MHz Channelling			
Channel	Frequency	Channel	Frequency
38G77C	37.32575	38G77C#	38.58575
38G78C	37.32925	38G78C#	38.58925
38G79C	37.33275	38G79C#	38.59275
38G80C	37.33625	38G80C#	38.59625
38G157C	37.60575	38G157C#	38.86575
38G158C	37.60925	38G158C#	38.86925
38G159C	37.61275	38G159C#	38.87275
38G160C	37.61625	38G160C#	38.87625
38G237C	37.88575	38G237C#	39.14575
38G238C	37.88925	38G238C#	39.14925
38G239C	37.89275	38G239C#	39.15275
38G240C	37.89625	38G240C#	39.15625
38G317C	38.16575	38G317C#	39.42575
38G318C	38.16925	38G318C#	39.42925
38G319C	38.17275	38G319C#	39.43275
38G320C	38.17625	38G320C#	39.43625

50 GHz Band 50.4 - 51.15 GHz

40 MHz Channelling

Channel	Frequency	Channel	Frequency
50G1A	50.440	50G1A#	50.940
50G2A	50.480	50G2A#	50.980
50G3A	50.520	50G3A#	51.020
59G4A	50.560	50G4A#	51.060
50G5A	50.600	50G5A#	51.100

10 MHz Channelling

Channel	Frequency	Channel	Frequency
50G1B3	50.44	50G1B3#	50.94
50G1B4	50.45	50G1B4#	50.95
50G2B1	50.46	50G2B1#	50.96
50G2B2	50.47	50G2B2#	50.97
50G2B3	50.48	50G2B3#	50.98
50G2B4	50.49	50G2B4#	50.99
50G3B1	50.50	50G3B1#	51.00
50G3B2	50.51	50G3B2#	51.01
50G3B3	50.52	50G3B3#	51.02
50G3B4	50.53	50G3B4#	51.03
50G4B1	50.54	50G4B1#	51.04
50G4B2	50.55	50G4B2#	51.05
50G4B3	50.56	50G4B3#	51.06
50G4B4	50.57	50G4B4#	51.07
50G5B1	50.58	50G5B1#	51.08
50G5B2	50.59	50G5B2#	51.09
50G5B3	50.60	50G5B3#	51.10
50G5B4	50.61	50G5B4#	51.11
50G5B5	50.62	50G5B5#	51.12

Band Plan for 50 GHz Band 50.4 - 51.15 GHz

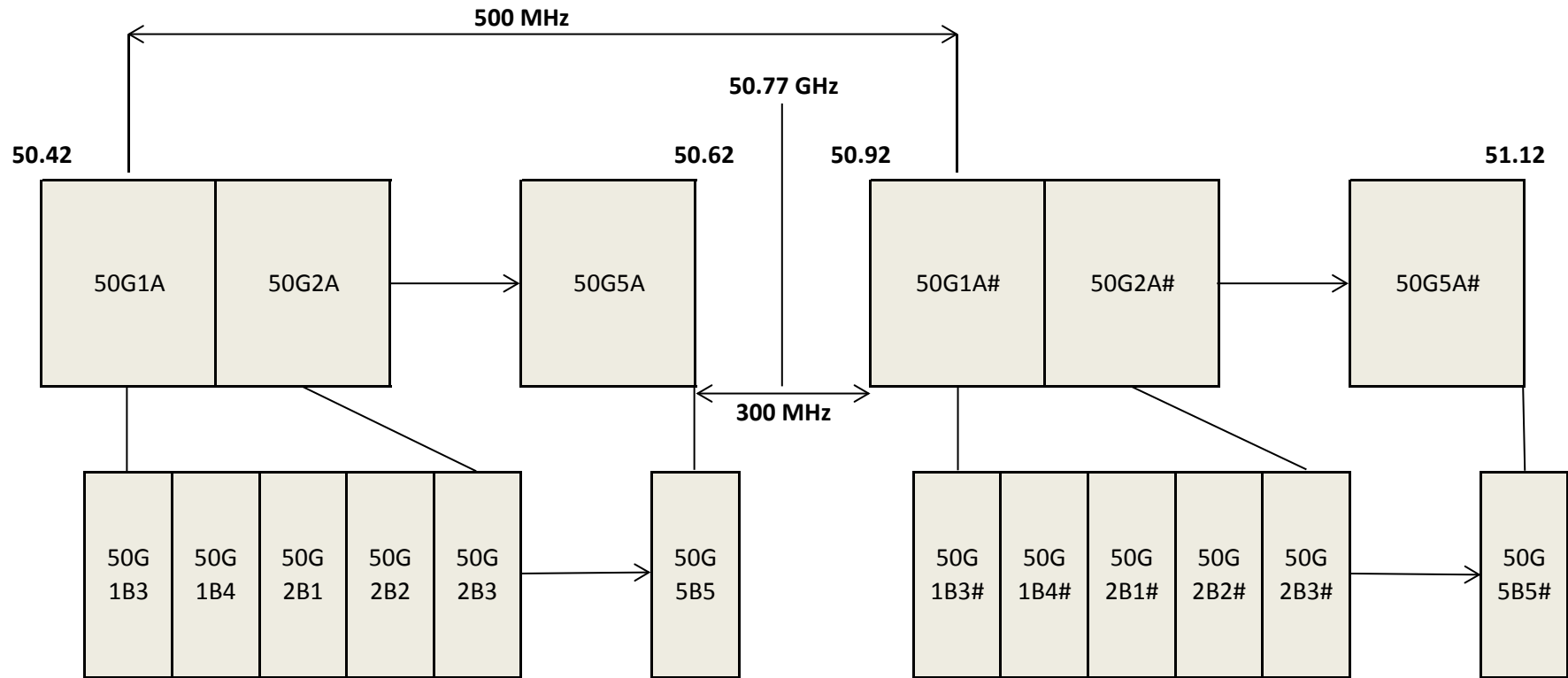

Channelling: 10 and 40 MHz

80 GHz Band 71.125 - 85.875 GHz**2250 MHz Channelling**

Channel	Frequency	Channel	Frequency
80G1A	72.250	80G1A#	82.250
80G2A	72.500	80G2A#	82.500
80G10A	74.500	80G10A#	84.500
80G11A	74.750	80G11A#	84.750

1750 MHz Channelling

Channel	Frequency	Channel	Frequency
80G1B	72.000	80G1B#	82.000
80G2B	72.250	80G2B#	82.250
80G3B	72.500	80G3B#	82.500
80G4B	72.750	80G4B#	82.750
80G5B	73.000	80G5B#	83.000
80G6B	73.250	80G6B#	83.250
80G7B	73.500	80G7B#	83.500
80G8B	73.750	80G8B#	83.750
80G9B	74.000	80G9B#	84.000
80G10B	74.250	80G10B#	84.250
80G11B	74.500	80G11B#	84.500
80G12B	74.750	80G12B#	84.750
80G13B	75.000	80G13B#	85.000

1250 MHz Channelling

Channel	Frequency	Channel	Frequency
80G1C	71.750	80G1C#	81.750
80G2C	72.000	80G2C#	82.000
80G3C	72.250	80G3C#	82.250
80G4C	72.500	80G4C#	82.500
80G5C	72.750	80G5C#	82.750
80G6C	73.000	80G6C#	83.000
80G7C	73.250	80G7C#	83.250
80G8C	73.500	80G8C#	83.500
80G9C	73.750	80G9C#	83.750
80G10C	74.000	80G10C#	84.000
80G11C	74.250	80G11C#	84.250
80G12C	74.500	80G12C#	84.500
80G13C	74.750	80G13C#	84.750
80G14C	75.000	80G14C#	85.000
80G15C	75.250	80G15C#	85.250

250 MHz Channelling			
Channel	Frequency	Channel	Frequency
80G1D	71.250	80G1D#	81.250
80G2D	71.500	80G2D#	81.500
80G3D	71.750	80G3D#	81.750
80G4D	72.000	80G4D#	82.000
80G5D	72.250	80G5D#	82.250
80G6D	72.500	80G6D#	82.500
80G7D	72.750	80G7D#	82.750
80G8D	73.000	80G8D#	83.000
80G9D	73.250	80G9D#	83.250
80G10D	73.500	80G10D#	83.500
80G11D	73.750	80G11D#	83.750
80G12D	74.000	80G12D#	84.000
80G13D	74.250	80G13D#	84.250
80G14D	74.500	80G14D#	84.500
80G15D	74.750	80G15D#	84.750
80G16D	75.000	80G16D#	85.000
80G17D	75.250	80G17D#	85.250
80G18D	75.500	80G18D#	85.500
80G19D	75.750	80G19D#	85.750

Band Plan for 80 GHz Band 71.125 – 75.875 / 81.125 – 85.875 GHz

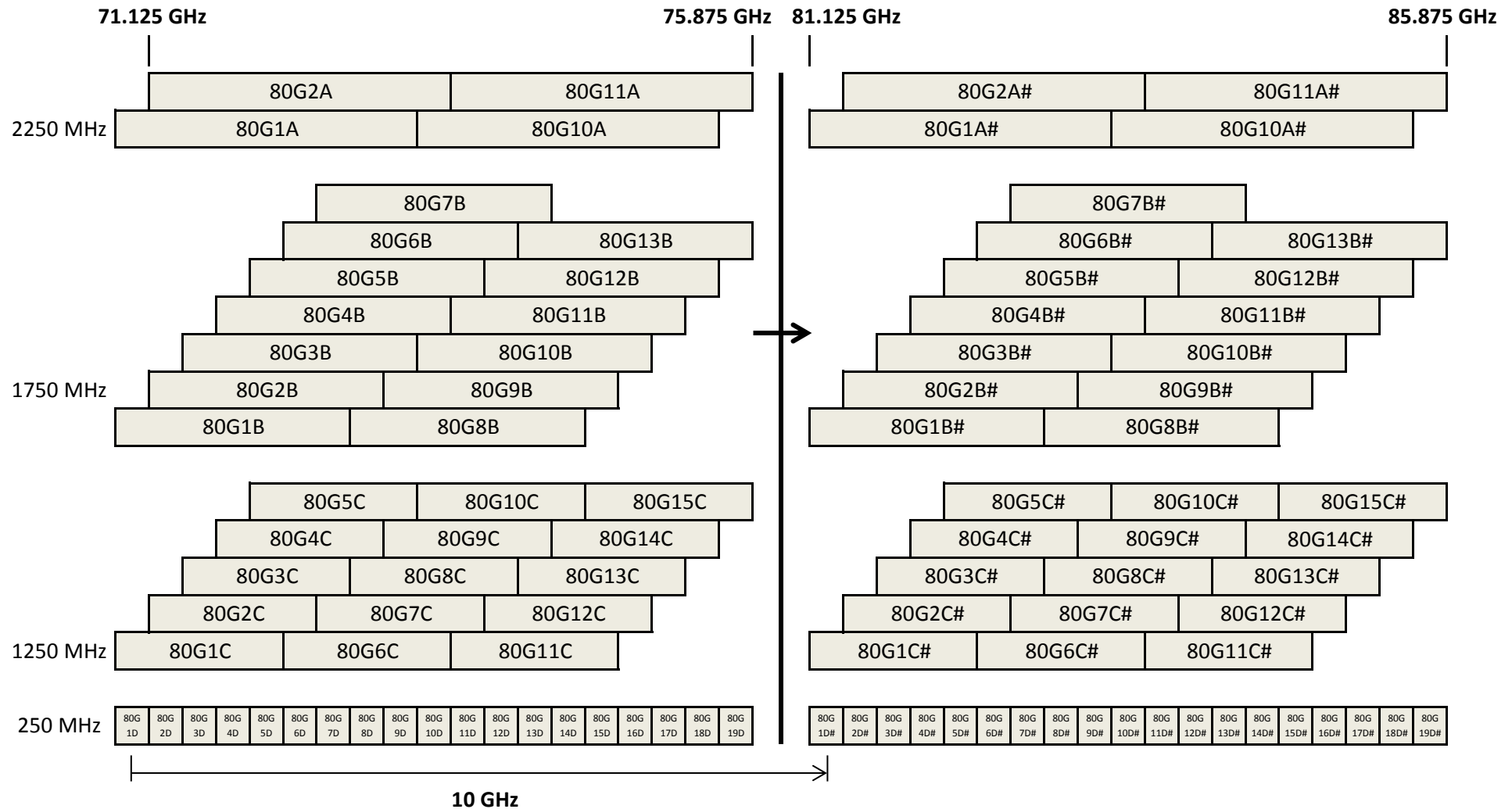

Channelling: 250, 1250, 1750 and 2250 MHz

Appendix 1

ITU-R recommendations used as the basis for Fixed Service band plans.

ITU-R references	Recommendation Title	New Zealand Band
Rec. F.635-6	Radio-frequency channel arrangements based on a homogeneous pattern for radio-relay systems operating in the 4 GHz band	4G
Rec. F.1099-3	Radio-frequency channel arrangements for high capacity digital radio-relay systems operating in the 4400 – 5000 MHz band	5G
Rec. F.383-9	Radio-frequency channel arrangements for high capacity fixed wireless systems operating in the lower 6 GHz band	6G
Rec. F.384-11	Radio-frequency channel arrangements for medium and high capacity digital fixed wireless systems operating in the 6 425-7 125 MHz band	7GL
Rec. F.385-10	Radio-frequency channel arrangements for fixed wireless systems operating in the 7 110-7 900 MHz band	7GM 7GU
Rec. F.386-9	Radio-frequency channel arrangements for medium and high capacity analogue or digital fixed wireless systems operating in the 8 GHz band	8GU
Rec. F.747-1	Radio-frequency channel arrangements for fixed wireless systems operating in the 10 GHz band	10G
Rec. F.387-12	Radio-frequency channel arrangements for radio-relay systems operating in the 11 GHz band	11G
Rec. F.497-7	Radio-frequency channel arrangements for fixed wireless systems operating in the 13 GHz frequency band	13G
Rec. F.636-1	Radio-frequency channel arrangements for radio-relay systems operating in the 15 GHz band	15G
Rec. F.595-10	Radio-frequency channel arrangements for fixed wireless systems operating in the 18 GHz band	18G
Rec. F.637-4	Radio-frequency channel arrangements for fixed wireless systems operating in the 23 GHz band	23G
Rec. F.749-3	Radio-frequency arrangements for systems of the fixed service operating in sub-bands in the 36-40.5 GHz band	38G